

Pogled X - Priključni ormarić, položaj uvodnica  
View X - Terminal box, cable gland position

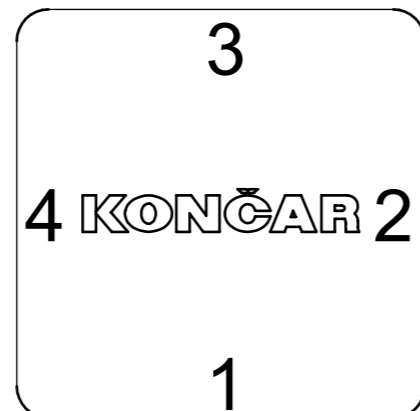
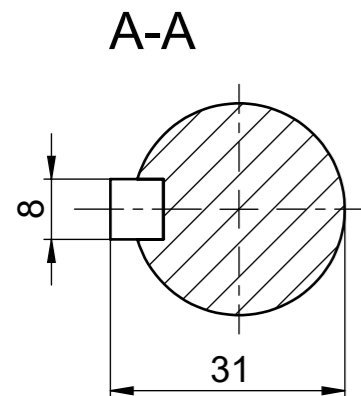

Tipa			Oblik
7AZ 112 STANDK			B14-F130
10.04.18.	Ime	Potpis	Broj crteža
Konstruirao	Antonić		20.18366-C
Odobrio	Prekrat		
KONČAR-MES ZAGREB, CROATIA			