

Pogled X - Priključni ormarić, položaj uvodnica
View X - Terminal box, cable gland position

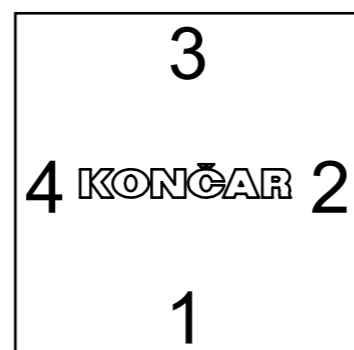
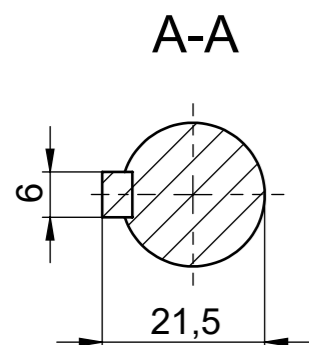

Tipa			Oblik
5AZ 80 STANDK			B34-F130/OG
Konstruirao	Ime	Potpis	Broj crteža
Mihaljević	Mihaljević		20.18270-G
Odobrio	Antonić		
KONČAR-MES ZAGREB, CROATIA			