

Pogled X - Priklučni ormarić, položaj uvodnica
View X - Terminal box, cable gland position

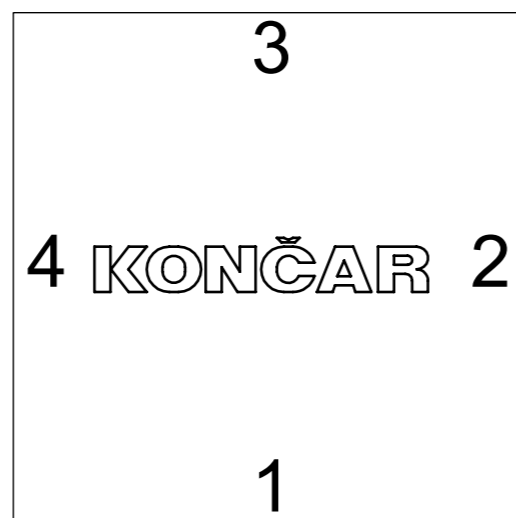
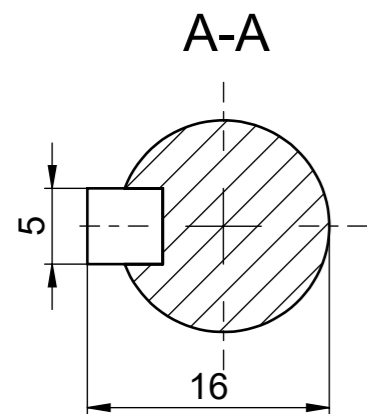

Tipa			Oblik
5AT 71 Exde STANDK			B35/OG
Konstruirao	Ime	Potpis	Broj crteža
Žigrović			20.17496-E
Odobrio	Prekrat		
KONČAR-MES ZAGREB, CROATIA			