

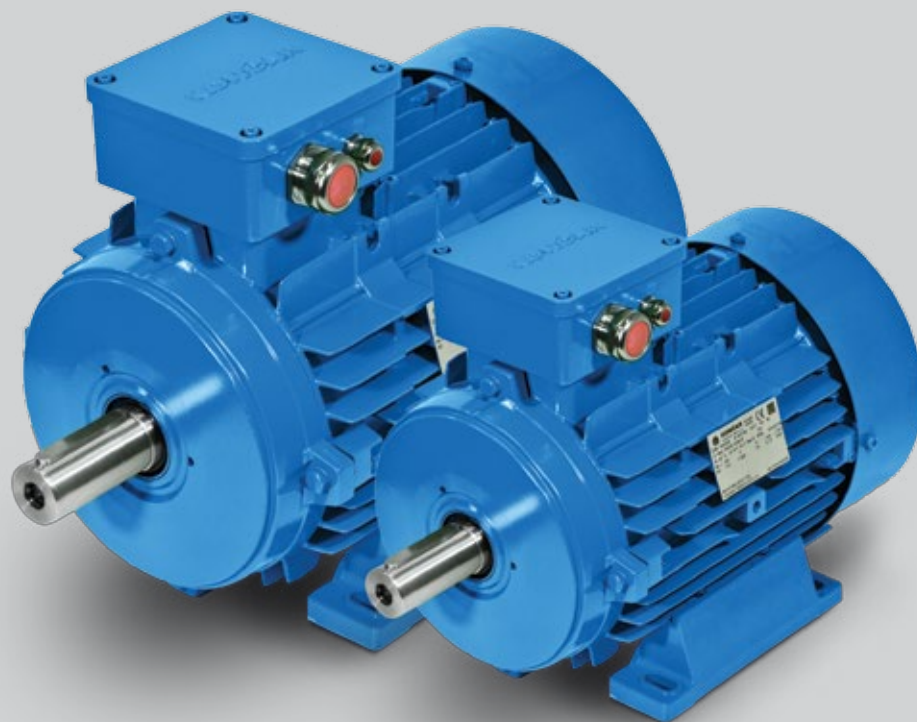

KONČAR
KONČAR - MES d.d.



ELEKTROMOTORI

ELECTRIC MOTORS

www.koncar-mes.hr

O NAMA

KONČAR-MES d.d. je članica KONČAR Grupe koja ima dugu tradiciju već više od 90 godina, a svoje proizvode isporučuje velikom broju kupaca diljem svijeta. Imamo široku paletu proizvoda koja su podržana s našim vlastitim razvojem, tehnologijom i kvalitetom usluga što predstavlja dobru osnovu za dugogodišnje ciljeve. Kroz naše poslovne strategije nastojimo biti prisutni u uspješnoj skupini proizvođača pogona na svjetskom tržištu. Jedan od naših najvećih prednosti su kompetentni i obrazovani zaposlenici s naglaskom na našim inženjerima koji koriste svoje znanje i sposobnosti pri primjeni novih ideja za naše proizvode. Težimo stalnom rastu naše proizvodnje ispunjavanjem želja naših kupaca, kao i ispunjavanjem različitih zahtjeva tržišta. Izvrsnost u proizvodnji elektromotora i pogona je bitna i ispunjavamo iste uz stalno poboljšanje tehnologije i proizvodnih procesa.

ABOUT US

KONČAR-MES Inc. is a member of Končar Group which has a long tradition for over 90 years and delivers its products to a large number of customers all around the world. We have a wide production range supported by our own development, technology and quality service which represents a good basis for our longterm goals. Through our business strategy we strive to be present within a successful group of drive technology manufactures in the world market. One of our most valuable assets are a competent and educated employees with an emphasis on our engineers who use their knowledge and capabilities when applying new ideas in our products. We strive for constant growth of our production by fulfilling the desires of our customers as well as meeting various market demands. The excellence in production of electromotors and drives is essential and we fulfill this by constantly improving the technology and production processes.

ÜBER UNS

KONČAR-MES AG ist Mitglied der Končar Gruppe die eine über 90 Jahre lange Tradition hat und die ihre Produkte an viele Kunden weltweit liefert. Wir haben eine breite Produktpalette, die von unserer eigenen Entwicklung, Technologie und Qualität Service unterstützt wird, die eine gute Basis für unsere langfristige Ziele darstellt. Durch unsere Geschäftsstrategie streben wir an, in einer erfolgreichen Gruppe von Antriebstechnik-Manufakturen auf dem Weltmarkt präsent zu sein. Eines unserer wertvollsten Vermögenswerte sind kompetente und ausgebildete Mitarbeiter mit einem Schwerpunkt auf unsere Ingenieure, die ihres Wissen und ihre Fähigkeiten für neue Ideen für unsere Produkte anwenden. Wir streben ein kontinuierliches Wachstum unserer Produktion an, in dem wir die Wünsche unserer Kunden erfüllen. Die Exzellenz in der Produktion von Elektromotoren und Antrieben ist von wesentlicher Bedeutung und wir erreichen dies durch die kontinuierliche Verbesserung der Technologie und Prozessoptimierung.

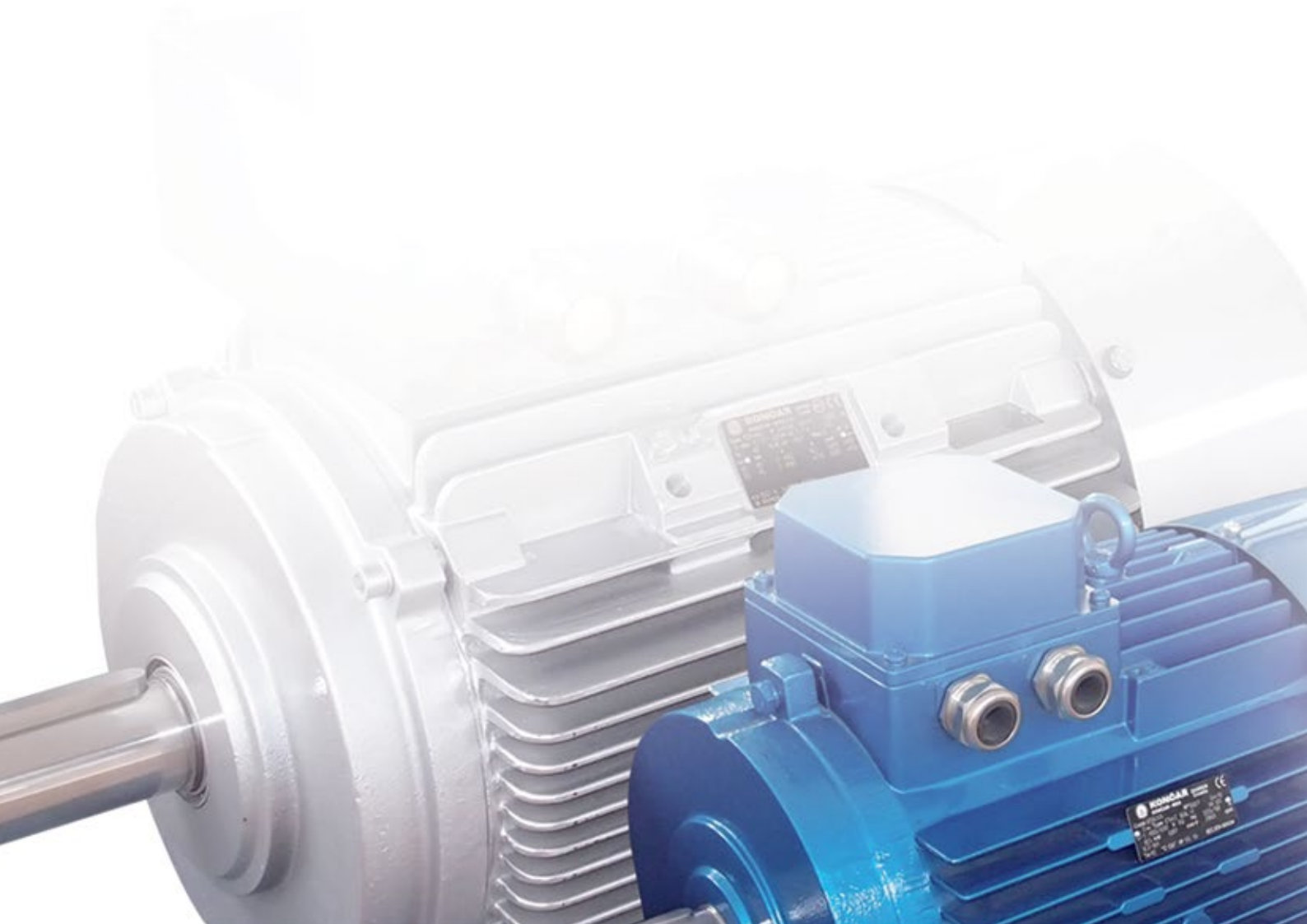

01

Tehnička razjašnjenja
Technical explanations
Technische Erläuterungen

02

Trofazni kavezni asinkroni motori
Three-phase squirrel cage
Dreiphasige Asynchronmotoren
mit Käfigläufer

03

Jednofazni asinkroni motori
Single-phase induction motors
Einphasige Asynchronmotoren



Sadržaj / Table of Contents / Inhalt

1.	TEHNIČKA RAZJAŠNJENJA	TECHNICAL EXPLANATIONS	TECHNISCHE ERLÄUTERUNGEN	1
1.1.	Općenito	General	Allgemeine Angaben	5
1.1.1.	Norme	<i>Standards</i>	Normen	6
1.1.2.	Nacionalni standardi	<i>National standards</i>	Nationale normen	7
1.1.3.	IEC klase efikasnosti	<i>IEC efficiency class</i>	IEC Effizienzklasse	8
1.1.4.	Označavanje motora	<i>Motors designation</i>	Motorenbezeichnung	10
1.2.	Mehanička izvedba	Mechanical features	Mechanische Ausführung	13
1.2.1.	Stupanj mehaničke zaštite – IP oznaka	<i>Index of mechanical protection - IP code</i>	Mechanische Schutzart - IP Zeichen	13
1.2.2.	Uvjeti okoline	<i>Ambient conditions</i>	Umgebungsbedingungen	14
1.2.3.	Izolacijski sustav	<i>Insulation system</i>	Isolationssystem	15
1.2.4.	Vrste pogona	<i>Type of duty cycles</i>	Betriebsarten	18
1.2.5.	Izvedbeni oblici	<i>Mounting arrangements</i>	Bauformen	20
1.2.6.	Mehanička izvedba	<i>Mechanical design</i>	Mechanische Ausführung	21
1.2.7.	Stupanj mehaničke zaštite – IK oznake	<i>Degree of mechanical protection – IK code</i>	Die Stufe des mechanischen Schutzes – IK Kodierung	22
1.2.8.	Vratilo	<i>Shaft</i>	Welle	22
1.2.9.	Ležajevi	<i>Bearings</i>	Lager	22
1.2.10.	Dozvoljene radijalne i aksijalne sile	<i>Permissible radial and axial forces</i>	Zulässige Radial- und Axialkräfte	23
1.2.11.	Priključna kutija	<i>Terminal box</i>	Klemmenkasten	26
1.2.12.	Uvod kabela u osnovnoj izvedbi	<i>Cable entry in basic motor design</i>	Kabeleinführung in der Grundausführung	28
1.2.13.	Vrste hlađenja	<i>Type of cooling</i>	Kühlungsarten	29
1.2.13.1.	Prisilna ventilacija za trofazne asinkrone motore	<i>Forced cooling for three-phase induction motors</i>	Fremdlüfter für dreiphasige Asynchronmotoren	31
1.2.14.	Vibracije	<i>Vibrations</i>	Vibrationen	33
1.3.	Električna izvedba	Electrical features	Elektrische Ausführung	34
1.3.1.	Napon i frekvencija	<i>Voltage and frequency</i>	Spannung und Frequenz	34
1.3.2.	Nominalna brzina i smjer vrtnje	<i>Rated speed and direction of rotation</i>	Nenn Drehzahl und Drehrichtung	35
1.3.3.	Nominalni moment	<i>Rated torque</i>	Nennmoment	35
1.3.4.	Nazivna struja	<i>Rated current</i>	Nennstrom	35
1.3.5.	Preopterećenje	<i>Overload capacities</i>	Überlastung	35
1.3.6.	Električna zaštita	<i>Electrical protection</i>	Elektrischer Schutz	36
1.3.7.	Termička zaštita	<i>Thermal protection</i>	Thermischer Schutz	37
1.3.8.	Način pokretanja	<i>Starting mode</i>	Anlaufarten	38
1.3.9.	Pogon preko frekvencijskog pretvarača	<i>Supply over frequency converter</i>	Frequenzrichterbetrieb	39
1.3.10.	Grijači namota	<i>Winding heaters</i>	Wicklungsheizung	40
1.3.11.	Buka	<i>Noise</i>	Geräusche	41
1.4.	Zaštita od korozije i završni premaz	Corrosion protection and final coating	Korrosionsschutz und Endanstrich	42
1.5.	Održavanje	Maintenance	Instandhaltung	43
1.6.	Pakiranje i transport	Packaging and transportation	Verpackung und Transport	43
1.7.	Dopuštena odstupanja podataka (IEC 60034-1)	Allowed tolerances (IEC 60034-1)	Zulässige Datenabweichungen (IEC 60034-1)	44
2.	TROFAZNI KAVEZNI ASINKRONI MOTORI	THREE PHASE SQUIRREL CAGE INDUCTION MOTORS	DREIPHASIGE ASYNCHRONMOTOREN MIT KÄFIGLÄUFER	46
2.1.	Općenito	General	Allgemeine Angaben	47
2.1.1.	IE1 trofazni kavezni asinkroni motori - STANDARD	<i>IE1 Three-phase Squirrel cage induction motors - STANDARD</i>	IE1 Dreiphasenasynchronmotoren mit Käfigläufer - STANDARD	48
2.1.2.	IE2 trofazni kavezni asinkroni motori - HIGH	<i>IE2 Three-phase squirrel cage induction motors - HIGH</i>	IE2 Dreiphasenasynchronmotoren mit Käfigläufer - HIGH	54
2.1.3.	IE3 trofazni kavezni asinkroni motori - PREMIUM	<i>IE3 Three-phase squirrel cage induction motors - PREMIUM</i>	IE3 Dreiphasenasynchronmotoren mit Käfigläufer - PREMIUM	59
2.2.	Višebrzinski motori	Multi-speed motors	Mehrtourige Motoren	66
2.2.1.	Sheme spajanja	<i>Connection diagrams</i>	Schaltschemen	67
2.2.2.	Dvobrzinski motori s konstantnim momentom na obje brzine – DAHLANDER	<i>Two-speed motors with constant torque at both SPEEDS – DAHLANDER</i>	Zweitourige Motoren mit konstantem Lastmoment auf beiden Drehzahlen – DAHLANDER	69
2.2.3.	Dvobrzinski motori za pogon ventilatora – DAHLANDER	<i>Two-speed fan rated motors – DAHLANDER</i>	Zweitourige Motoren für Lüfterantrieb – DAHLANDER	70
2.2.4.	Dvobrzinski motori za pogon ventilatora – DVA ODVOJENA NAMOTA.	<i>Two-speed fan rated motors - TWO SEPARATE WINDINGS</i>	Zweitourige Motoren für Lüfterantriebe - ZWEI GETRENNTEN WICKLUNGEN	71
2.2.5.	Dvobrzinski motori s konstantnim momentom na obje brzine – DVA ODVOJENA NAMOTA	<i>Two-speed motors with constant torque AT both speeds - TWO SEPARATE WINDINGS</i>	Zweitourige Motoren mit konstantem Moment auf beiden Drehzahlen - ZWEI GETRENNTEN WICKLUNGEN	72
2.2.6.	Dvobrzinski motori za pogon ventilatora – DVA ODVOJENA NAMOTA	<i>Two-speed fan rated motors - TWO SEPARATE WINDINGS</i>	Zweitourige Lüfterantriebsmotoren - ZWEI GETRENNTEN WICKLUNGEN	73
2.2.7.	Dvobrzinski motori s konstantnim momentom na obje brzine – DVA ODVOJENA NAMOTA	<i>Two-speed motors with constant torque AT both speed - TWO SEPARATE WINDINGS</i>	Zweitourige Motoren mit konstantem Moment auf beiden Drehzahlen - ZWEI GETRENNTEN WICKLUNGEN	74
2.2.8.	Izvedba motora s jednim namotom u Dahlander spoju	<i>One winding in Dahlander connection</i>	Motorausführung mit einer Wicklung in Dahlander-Schaltung	74

2.2.9.	Trobrzinski motori s konstantnim momentom - DVA ODVOJENA NAMOTA i DAHLANDER	<i>Three-speed motors with constant torque - TWO SEPARATE WINDINGS AND DAHLANDER</i>	Dreitourige Motoren mit konstantem Moment - ZWEI GETRENNTEN WICKLUNGEN UND DAHLANDER	75
2.2.10.	Trobrzinski motori za pogon ventilatora – DVA ODVOJENA NAMOTA i DAHLANDER	<i>Three-speed fan rated motors - TWO SEPARATE WINDINGS AND DAHLANDER</i>	Dreitourige Lüfterantriebsmotoren - ZWEI GETRENNTEN WICKLUNGEN UND DAHLANDER	76
2.3.	Motori brodske izvedbe	<i>Marine design motors</i>	Motoren in schiffs-ausführung	77
2.4.	Ostale mogućnosti (dodatne izvedbe motora i prigradivanja na motor)	<i>Other options (additional motor arrangements and mounting designs)</i>	Andere Optionen (weitere Motorausführungen - und Anbauten)	80
2.5.	Mjerne skice	<i>Dimensional drawing</i>	Masszeichnungen	82
3.	JEDNOFAZNI ASINKRONI MOTORI	SINGLE PHASE INDUCTION MOTORS	EINPHASIGE ASYNCHRONMOTOREN	80
3.1.	Općenito	<i>General</i>	Allgemeine Angaben	85
3.2.	Sheme spajanja	<i>Connection diagram</i>	Schaltsschemen	86
3.3.	Standardne izvedbe	<i>Standard design</i>	Grundausführung	87
3.4.	Tehnički podaci	<i>Technical data</i>	Technische Daten	89
3.5.	Mjerne skice	<i>Dimensional drawing</i>	Masszeichnungen	92

01

**TEHNIČKA
RAZJAŠNENJA
TECHNICAL EXPLANATIONS
TECHNISCHE ERLÄUTERUNGEN**



1.1. Općenito

Ovaj katalog sadrži osnovne tehničke podatke niskonaponskih trofaznih i jednofaznih asinkronih kaveznih zatvorenih elektromotora. Jednofazni motori izvode se kao jednobrzinski, dok se trofazni izvode kao jednobrzinski i više brzinski. Red snaga jednobrzinskih motora u skladu je s propisima IEC 60034-1.

Svi motori proizvode se s prigradnim mjerama prema IEC 60072-1, čime je omogućena brza ugradnja i zamjena motora bilo čije proizvodnje. Motori su namijenjeni za primjenu u najrazličitijim elektromotornim pogonima, a osnovne su im značajke:

- standardni europski napon 230 ili 400V \pm 10% i frekvencija 50 Hz
- visoka korisnost η i visoki faktor snage $\cos \varphi$
- niska razina buke
- suvremeno oblikovanje
- prilagodljivost različitim zahtjevima elektromotornih pogona (specijalne mehaničke i električke izvedbe)
- izolacijski sustav klase F, sa zagrijavanjem u klasi B
- sigurnost u pogonu
- razgradivost svih ugrađenih dijelova i komponenti
- jednostavno održavanje

1.1. General

This catalogue comprises basic technical data for low voltage three phase and single-phase squirrel cage asynchronous motors.

Single-phase motors are made as single speed, and three phases are made as single and multi speed motors. Single-phase electric motors power range is in accordance with IEC 60034-1 regulations.

All motors are produced with mounting dimensions according to IEC 60072-1, enabling quick motor mounting and replacement of motor of any other producer.

Motors are intended to be used in various electric motor drives and their basic properties are:

- *Standard European voltage 230 or 400V \pm 10% and frequency 50Hz*
- *High efficiency η and power factor $\cos \varphi$*
- *Low noise level*
- *Modern design*
- *Adaptability to different requirements of electric motor drives (special mechanical and electrical designs)*
- *Insulation system in F class with temperature rise in B class*
- *Safety in operation*
- *recyclable parts and components*
- *Simple maintenance*

1.1. Allgemeine Angaben

Dieser Katalog enthält technische Grunddaten drei- u. einphasiger Niederspannungssynchronmotoren geschlossener Ausführung. Einphasige Motoren sind nur als eintourige ausgeführt, dreiphasige Motoren führt man als ein- u. mehrtourige aus. Die Leistungszuordnung eintouriger Motoren ist im Einklang mit IEC 60034-1 Vorschriften.

Alle Motoren sind mit Anbaumaßen nach IEC 60072-1 hergestellt, womit schnelles einbauen und austauschen der Motoren beliebiger Fabrikate ermöglicht ist. Die Motoren sind für verschiedensten elektromotorischen Antriebe anwendbar und haben folgende Grundmerkmale.

- europäische Normspannung 230 oder 400V \pm 10%, 50Hz
- hoher Wirkungsgrad η und hoher Leistungsfaktor $\cos \varphi$
- niedriger Geräuschpegel
- moderne Gestaltung
- anpassungsfähig auf verschiedene Vorderungen elektromotorischer Antriebe (mechanische und elektrische Sonderausführungen)
- Isolationssystem der Temperaturklasse F mit der Erwärmung nach der Temperaturklasse B
- betriebsicher
- rezyklierbare Teile und Komponenten
- einfache Instandhaltung

1.1.1. Norme

Motori su projektirani, proizvedeni i ispitani u skladu s normama i direktivama prema Tablici 1.1.

1.1.1. Standards

Motors are developed, produced and tested according to standards and directives according to table 1.1.

1.1.1. Normen

Die Motoren sind projektiert, hergestellt und geprüft im Einklang mit kroatischen Normen und Vorschriften nach der Tabelle 1.1.

Tablica 1.1. / Table 1.1. / Tabelle 1.1.

Norme i propisi	Standards and directives	Normen und Vorschriften	IEC/EN/HRN
Električni rotacijski strojevi, red snaga i opći zahtjevi	<i>Electrical rotating machines, rating and general requests</i>	Drehende elektrische Maschinen, Leistungsreihe und allgemeine Bestimmungen.	IEC 60034-1
Metode za određivanje gubitaka i korisnosti	<i>Methods for determining losses and efficiency</i>	Methoden zur Ermittlung der Verluste und Effizienz	IEC 60034-2
Stupnjevi zaštite el. rotacijskih strojeva	<i>Degrees of protection of electrical rotating machines</i>	Schutzgrade drehender elektrischer Maschinen	IEC 60034-5
Načini hlađenja el. rotacijskih strojeva	<i>Cooling methods of electrical rotating machines</i>	Kühlungsarten drehender elektrischer Maschinen	IEC 60034-6
Način označavanja tipa konstrukcije, ugradnje i pozicioniranja priključne kutije	<i>Designation for type of construction, instalation and terminal box position</i>	Kennzeichnung des Konstruktionstyps, des Einbaues und der Klemmkastenpositionierung	IEC 60034-7
Oznake priključaka i smjer vrtnje	<i>Terminal markngs and direction of rotation</i>	Anschlussbezeichnungen und Drehrichtung	IEC 60034-8
Granične vrijednosti buke	<i>Noise limits</i>	Lärmgrenzwerte	IEC 60034-9
Ugrađena termička zaštita	<i>Built-in thermal protection</i>	Eingebauter thermischer Schutz	IEC 60034-11
Karakteristike ponovnog starta električnih rotacijskih strojeva	<i>Restarts characteristics of electrical rotating machines</i>	Wiederanlaufverhalten drehender elektrischer Maschinen	IEC 60034-12
Mehaničke vibracije	<i>Mechanical vibrations</i>	Mechanische Vibrationen	IEC 60034-14
Klase učinkovitosti (IE code)	<i>Efficiency classes (IE-code)</i>	Effizienzklassen (IE-Kodierung)	IEC 60034-30
IEC-normirani naponi	<i>IEC – standardised voltages</i>	IEC – Normspannungen	IEC 60038
Redovi dimenzija i izlaznih snaga za rotirajuće električne strojeve	<i>Dimensions and Output Series for Rotating Electrical Machines</i>	Leistungszugeordnete Anbaumassen für drehende elektrische Maschinen	IEC 60072 EN 50347
Termičko vrednovanje i klasifikacija izolacijskih sustava	<i>Thermal evaluation and classification of insulation systems</i>	Thermische Wertschätzung und die Klassifizierung der Isolationssysteme	IEC 60085

1.1.2. Nacionalni standardi

Motori su sukladni s IEC i EN standardima i direktivama koje zamjenjuju nacionalne standarde u zemljama EU : EMC 2014/30/EU, 2014/35/EU, 2006/42/IEC, 2009/125/EC. Motori su u skladu s Hrvatskim normama i pravilnicima (Pravilnik o električnoj opremi namijenjenoj za uporabu unutar određenih naponskih granica i Pravilnik o elektromagnetskoj kompatibilnosti). Naši motori za IE2 (Visoka efikasnost) i IE3 (premium efikasnost) ispunjavaju minimalne zahtjeve učinkovitosti u skladu s EU direktivom 640/2009 i IEC60034-30.

Naši motori ne sadrže zabranjene materijale u skladu s direktivama 2011/65/EC i 2003/311/EC. Sukladnost se garantira CE oznakom na natpisnoj pločici motora odnosno (na zahtjev) proizvođačkom IZJAVOM O SUKLADNOSTI.

NA POSEBAN ZAHTEJEV MOGU SE IZRADITI MOTORI KOJI ODGOVARAJU DRUGIM NACIONALNIM STANDARDIMA.

1.1.2. National standards

Motors are in accordance with IEC and EN standards and directives which are replacing national standards in EU countries: EMC 2014/30/EU, 2014/35/EU, 2006/42/IEC, 2009/125/EC. Motors are in accordance with Croatian normatives and regulations (Regulatives about electrical equipment ment to be used inside certain voltage limits and Regulatives about electromagnetic compatibility).

Our motors for IE2 (high efficiency) and IE3 (premiu efficiency) fulfill minimum requirements for efficiency in accordance with EU directive 640/2009 and IEC 60034-30.

Our motors do not have forbidden materials in accordance with directives 2011/65/EC and 2003/311/EC.

Compatibility is guaranteed with CE marking on nameplate of motor and (upon request) producers CE declaration.

ONSPECIALREQUEST, MOTORSCANBEMADE TO FULFILL OTHER NATIONAL STANDARDS.

1.1.2 Nationale normen





Die Motoren sind im Einklang mit der IEC/EN Normen und Richtlinien, welche die nationale Normen in EU Länder ersetzen: EMC 2014/30/EU, 2014/35/EU, 2006/42/IEC, 2009/125/EC.

Die Motoren sind im Einklang mit kroatischen Normen und Vorschriften (die Vorschrift über elektrische Ausrüstung, welche für den Einsatz innerhalb bestimmter Spannungsgrenzen anwendbar ist und die Vorschrift über elektromagnetische Verträglichkeit).

Unsere Motoren für IE2 (hohe Effizienz) und IE3 (Premiueffizienz) erfüllen die minimale Effizienz anforderungen im Einklang mit der EU Richtlinie 640/2009 und IEC60034-30. Unsere Motoren enthalten keine verbotene Rohstoffe im Einklang mit Richtlinienen 2011/65/EC und 2003/311/EC.

Die Kompatibilität ist garantiert mit der CE Markierung auf dem Motortypenschild und (auf Anfrage) der Herstellererklärung.

AUF SONDERANFRAGE KÖNNEN DIE MOTOREN IM EINKLANG MIT ANDEREN NATIONALEN NORMEN HERGESTELLT WERDEN.

 www.koncar-mes.hr	EU IZJAVA O SUKLADNOSTI EU DECLARATION OF CONFORMITY		
Mi, proizvođač/ We, the manufacturer: KONČAR - MES d.d. Fallerovo šetaliste 22, PP 202, 10002 Zagreb, Republic of Croatia			
Izjavujemo i potvrđujemo pod punom odgovornošću da su naši proizvodi: / Declare herewith that our products:			
IEC JEDNOFAZNI I TROFAZNI NISKO NAPONSKI ASINKRONI KAVEZNI MOTORI Serijska i veličina 5AZC 63-112, 5AZCD 63-112, 5AZ/AZK 56-160 i 7AZ/AZK 90-315 jednobrinski, višebrinski i s prigradenim elektromagnetskim kočnicama			
IEC SINGLE PHASE AND THREE PHASE LOW VOLTAGE SQUIRREL CAGE INDUCTION MOTORS Series and size 5AZC 63-112, 5AZCD 63-112, 5AZ/AZK 56-160 and 7AZ/AZK 90-315 single speed, multi speed and with adapted electromagnetic brakes			
konstruirani prema važećim Zakonima, normama i propisima te je dizajnirani prema važećim Zakonima, normama i propisima te je njihova sukladnost utvrđena provedenim ispitivanjima s slijedećim regulacijama, and by conducted tests ensured to comply to industrial standards:			
EN 60034-1	Električni rotacijski strojevi- dio 1: Nazivne vrijednosti i radna svojstva / Electrical rotating machines – part 1: ratings and performance		
EN 60034-2	Električni rotacijski strojevi- dio 2: Normirane metode određivanja gubitaka i korisnosti ispitivanjima (isključujući strojeve za vučna vozila) / Electrical rotating machines – part 2: methods for determining losses and efficiency		
EN 60034-5	Električni rotacijski strojevi- dio 5: Stupnjevi zaštite posredstvom konstrukcijom rotacijskih strojeva (IP kod) / Electrical rotating machines – part 5: degrees of protection (IP code)- classification		
EN 60034-6	Električni rotacijski strojevi- dio 6: Način hlađenja (IC kod) / Electrical rotating machines – part 6: methods of cooling (IC code)		
EN 60034-7	Električni rotacijski strojevi- dio 7: Klasifikacije tipova konstrukcije, načina montaže i smještaja priključne kutije (IM kod) / Electrical rotating machines – part 7: classification of types of constructions, mounting, (IM code)		
EN 60034-8	Električni rotacijski strojevi- dio 8: Označavanje stezajki i smjera vrtnje / Electrical rotating machines – part 8: terminal markings and direction of rotation		
EN 60034-9	Električni rotacijski strojevi- dio 9: Granica buke / Electrical rotating machines – part 9: noise limits		
EN 60034-11	Električni rotacijski strojevi- dio 11: Termička zaštita / Electrical rotating machines – part 11: thermal protection		
EN 60034-12	Električni rotacijski strojevi- dio 12: Zaležna svojstva jednobrzinskih trofaznih kaveznih indukcijskih motora / Electrical rotating machines – part 12: starting performance of single-speed three-phase motors		
EN 60034-14	Električni rotacijski strojevi- dio 14: Mehaničke vibracije strojeva visine vratila 56 mm i više / Electrical rotating machines – part 14: mechanical vibrations with shaft heights 56 mm and higher		
EN 60034-25	Električni rotacijski strojevi- dio 25: Vodič za projektiranje i značajke kaveznih asinkronih motora projektiranih za pogon preko pretvarača / Rotating electrical machines – Part 25: Guide for the design and performance of cage induction motors specifically designed for converter supply		
EN 60034-30	Električni rotacijski strojevi- dio 30: Klase učinkovitosti (IE kod) / Electrical rotating machines – part 30: efficiency classes (IE-code)		
EN 60038	IEC-normirani naponi / IEC standard voltages		
EN 60072	Redovi dimenzija i izlaznih snaga za rotirajuće električne strojeve- kućišta 56 do 400 i pribornica od 55 do 1080 / Dimensions and output series for rotating electrical machines - Part 1: Frame numbers 56 to 400 and flange numbers 55 to 1080		
EN 50347	Trofazni indukcijski motori opće namjene, normiranih dimenzija i izlaza - Kućišta za visine osovine 56 do 315 i veličine pribornica 55 do 1080 / Dimensions and Output Part 1: Frame Numbers 56 to 400 and Flange Numbers 55 to 1080		
EN 60085	Termičko vrednovanje i klasifikacija izolacijskih sustava / Electrical insulation – Thermal evaluation and designation		
EN 60529	Stupnjevi zaštite osigurani kućištima (IP kod) / Degrees of protection provided by enclosures (IP Code)		
EN 60204-1	Sigurnost strojeva – Električna oprema strojeva-Opći zahtjevi / Safety of machines: Electrical equipment of machines. General requirements		
ISO 281	Kotirajući ležajevi - Ocjena dinamičkog opterećenja i vijeka trajanja / Rolling bearings – Dynamic load ratings and rating life		
ISO 8821	Mehaničke vibracije – Uravnotežavanje --Dogovor za vratilo i ključ za montažu / Mechanical vibration – Balancing -- Shaft and fitment key convention		
EN 62262	Stupnjevi zaštite za električnu opremu osigurani kućištima od vanjskih mehaničkih udara (IK kod) / Degrees of protection by enclosures for electrical equipment against external mechanical impacts (IK code)		
Ovi proizvodi sukladni su slijedećim direktivama Europske unije / These products comply with the following European Council's Directives:			
EMC regulativa 2014/30/EU (2004/108/EC) - s obzirom na intrinzičke karakteristike emisije i razina imuniteti, su u sukladnosti sa EN 60034-1 (za NISKONAPONSKIE TROFAZNE ASINKRONE KAVEZNE MOTORE). Dokaz o ispunjavanju zahtjeva: Evaluation Report 21580EMC150049 (KONČAR-IE1) / EMC Directive 2014/30/EU (2004/108/EC) , regarding the intrinsic characteristics to emission and immunity levels, are in conformity with EN 60034-1 for THREE PHASE LOW VOLTAGE SQUIRREL CAGE INDUCTION MOTORS). Proof of compliance: Evaluation Report 21580EMC150049 (KONČAR-IE1).			
Niskonaponska regulativa 2014/35/EU -Ova izjava o sukladnosti izrađena je u skladu sa modulom A: Unutarnja kontrola proizvodnje / Low Voltage Directive 2014/35/EU -This certificate of conformity is according to module A: Internal production control.			
Regulativa o strojevima 2006/42/EC - Izjava o ugradnji - Navedeni proizvodi ne mogu se pustiti u rad dok stroj u koji se ugrađuju nije u sukladnosti sa MC 2006/42/EC. / Machinery Directive 2006/42/EC - Certificate of incorporation - The above products cannot put into service until the machinery into which they are incorporated has been declared to be in conformity with MC 2006/42/EC.			
ErP regulativa 2009/125/EC - Ova izjava o sukladnosti izrađena je u skladu sa zahtjevima 2009/125/EC regulative za visoku učinkovitost motora. / ErP Directive 2009/125/EC -This certificate of conformity is according 2009/125/EC Directive that requires high efficiency ratings for motors.			
Regulativa 2011/65/EU - Izjava je sukladna Regulativi o ograničenju uporabe određenih opasnih tvari u električnoj i elektroničkoj opremi (preinačeno), uključujući 2011/65/EU / Directive 2011/65/EU - Declaration of conformity with the restriction of the use of certain hazardous substances in electrical and electronic equipment (recast), including 2011/65/EU.			
Upute za rukovanje i održavanje moraju biti poštivani. / Safety instructions and instruction for use and maintenance must be respected.			
Odgovorna osoba proizvođača / Responsible person of the manufacturer: Simon Eregovac			
Zagreb, 29.09.2018.		MPWWS	Potpis/signature: 
MES OB 8.2.5.8/10 29.09.2018.			

Slika / Picture / Bild 1.1.

Izjava o sukladnosti / Declaration of Conformity / Konformitätserklärung

1.1.3 IEC klase efikasnosti

Novi standardi i propisi (ErP directive – Energy Related Products i EU direktiva 2009/125/EC) za učinkovitost asinkronih motora, postaju obvezni u svim EU zemljama. Svi su bazirani na IEC standardima 60034-30 koji definiraju tri klase učinkovitosti (IE1 do IE3) za motore koji rade na 50Hz i 60Hz.

Nove klase učinkovitosti su definirane u IEC 60034-30 za asinkrone motore (IE=International Efficiency):

- IE1 (standardna učinkovitost)
- IE2 (visoka učinkovitost)
- IE3 (premium učinkovitost).

U skladu s novom nomenklaturom, metoda mjerenja se također promijenila: učinkovitost mora biti određena prema IEC 60034-2-1. Promjene počinju važiti prema ovoj dinamici:

- od 16.06.2011. zakonski propisana minimalna učinkovitost prema EU regulativi postaje IE2 za indukcijske motore u S1 vrsti pogona
- od 01.01.2015. zakonski propisana minimalna učinkovitost mora biti IE3 za motore snaga od 7,5 kW do 375 kW ili se kao alternativa moraju koristiti IE2 motori u kombinaciji s frekvenzijskim pretvaračem
- od 01.01.2017. zakonski propisana minimalna učinkovitost mora biti IE3 za snage motora od 0,75 kW do 375 kW, ili se kao alternativa moraju koristiti IE2 motori u kombinaciji s frekvenzijskim pretvaračem.

Minimalne vrijednosti učinkovitosti koje motore spomenutih polariteta i snaga moraju postići prema direktivi IEC 60034-30 su prikazane u tablici 0.1.3.

Novi standardi i propisi se ne odnose na sljedeće motore:

- Motore koji rade potopljeni u tekućinu
- Motore koji su potpuno integrirani u proizvod (npr. reduktor, pumpa, ventilator, kompresor, itd.)
- Motori koji su posebno konstruirani za rad pod sljedećim uvjetima:
 - na visini većoj od 4000 m n.v.
 - na temperaturi okoline većoj od 60°C
 - na temperaturi okoline ispod -30°C (bilo koji motor)
 - za motore koji imaju rashladnu tekućinu na ulazu temperature ispod 0°C ili iznad 32°C
 - motori za zone ugrožene eksplozijom – Direktiva 94/9/EC
- kočione motore
- 8 i više polne motore
- Višebrzinske motore
- Sinkrone motore
- Motore za intermitirani pogon S2-S9 s nazivnim faktorom manjim od 80%
- Motore koji su posebno razvijeni za pogon preko frekvenzijskog pretvarača

1.1.3 IEC efficiency class

The new standards and legislation

(ErP directive - ErP = Energy related Products and EU directive 2009/125/EC) for efficiency of asynchronous motors are become national law in all EU countries. They are based on IEC standard 60034-30 which defines three efficiency classes (from IE1 – IE3) for 50 and 60 Hz motors.

New efficiency classes have been defined in IEC 60034-30 for asynchronous motors (IE= International Efficiency):

- IE1 (Standard Efficiency)
- IE2 (High Efficiency)
- IE3 (Premium Efficiency)

In addition to the new nomenclature, the measuring technique has also changed: The efficiencies should be determined corresponding to IEC 60034-2-1.

The changes become effective on these dates:

- From 16.06.2011: *The legally specified minimum efficiency IE2 for induction motors in S1 duty must be maintained according to the EU regulation*
- From 01.01.2015: *The legally specified minimum efficiency IE3 must be maintained for power ratings from 7.5 kW to 375 kW or as alternative, an IE2 motor plus frequency inverter*
- From 01.01.2017: *The legally specified minimum efficiency IE3 must be maintained for power ratings from 0.75 kW up to 375 kW or as alternative, an IE2 motor plus converter*

Minimal efficiency values which motors of mentioned polarities and output powers must achieve in accordance with IEC 60034-30 in aforementioned efficiency degrees/ classes are listed in the Table 0.1.3.

The following motors are not involved:

- Motors designed for operation completely submerged in a liquid;
- Motors that are completely integrated into a product (e.g. a gear unit, a pump, a fan or a compressor)
- Motors that have been specifically designed for operation under the following conditions:
 - at altitudes greater than 4000 meters above sea level;
 - at ambient temperatures above 60 °C;
 - at ambient temperatures below -30 °C (any motor);
 - at cooling liquid temperatures at the product intake of below 0 °C or above 32 °C;
- Motors for hazardous zones - Directive 94/9/ EC
- Brake motors
- 8-pole and more pole motors
- Pole-changing motors
- Synchronous motors
- Motors for intermittent duty S2- S9 with rated factor less than 80%
- Motors that have been specifically developed for converter operation

1.1.3 IEC Effizienzklasse

Neue Normen und Vorschriften (ErP Richtlinien - ErP= Energy related Products und EU Richtlinie 2009/125/EC) für die Effizienz von Asynchronmotoren sind pflichtig in allen EU Ländern. Die sind auf der IEC Normen 60034-30 basiert, welchen drei Effizienzklassen definieren (IE1 bis IE3) für 50 und 60 Hz Motoren.

Neue Effizienzklassen sind vorgeschrieben in IEC 60034-30 für Asynchronmotoren (IE= International Efficiency):

- IE1 (Standardeffizienz)
- IE2 (hohe Effizienz)
- IE3 (Premium Effizienz)

Zugefügt auf diese neue Bezeichnung hat es sich die Messmethode geändert: Die Effizienz muss im Einklang mit IEC 60034-2-1 bestimmt werden. Die Veränderungen beginnen zu gelten nach folgendem Zeitplan:

- Ab 16.06.2011: gesetzlich vorgeschriebene Mindesteffizienz gemäss der EU Richtlinie wird IE2 sein.
- Ab 1.1.2015: gesetzlich vorgeschriebene Mindesteffizienz muss IE3 für die Motoren der Leistungen von 7,5 kW bis 375 kW sein werden oder als Alternative muss man den IE2 Motor kombiniert mit dem Frequenzumrichter einsetzen.
- Ab 1.1.2017: gesetzlich vorgeschriebene Mindesteffizienz muss IE3 sein. Für die Motoren der Leistungen der 0,75 kW bis 375 kW sein werden oder als Alternativ muss man den IE2 Motor kombiniert mit dem Frequenzumrichter einsetzen.

Die Mindesteffizienzwerte, welche die Motoren erwähnter Polaritäten und Ausgangsleistungen nach der Richtlinie IEC 60034-30 erreichen müssen sind in der Tabelle 0.1.3 dargestellt.

Diese Vorschrift bezieht sich nicht auf folgende Motoren:

- In der Flüssigkeit getauchte Motoren
- Im Antrieb komplett eingebaute Motoren (z.B. im Getriebe, der Pumpe, dem Ventilator, dem Kompressor usw.)
- Sonderkonstruierte Motoren, die unter folgenden Bedingungen arbeiten:
 - auf mehr als 4000 m über dem Meeresspiegel
 - auf Umgebungstemperaturen über 60 °C
 - auf Umgebungstemperaturen unter -30 °C
 - Welche die Kühlfüssigkeitseingangstemperatur unter 0°C oder über 32°C haben
 - Welche für die Gefahrenzonen bestimmt sind – Richtlinie 94/9/EC
- Bremsmotoren
- 8-polige und mehrpolige Motoren
- Polumschaltbare Motoren
- Synchronmotoren
- Motoren für intermitierender Betriebsarten S2-S9 mit dem Leistungsfaktor weniger als 80 %
- Motoren welche für den FU-Betrieb besonders entwickelt sind

Tablica 1.2. / Table 1.2. / Tabelle 1.2.

50 Hz	P	2p=2				2p=4				2p=6				2p=8			
		Standard	High	Premium	Sup. Prem.	Standard	High	Premium	Sup. Prem.	Standard	High	Premium	Sup. Prem.	Standard	High	Premium	Sup. Prem.
		kW	IE1	IE2	IE3	IE4	IE1	IE2	IE3	IE4	IE1	IE2	IE3	IE4	IE1	IE2	IE3
0,12	45,0	53,6	60,8	66,5	50,0	59,1	64,8	69,8	38,3	50,6	57,7	64,9	31,0	39,8	50,7	62,3	
0,18	52,8	60,4	65,9	70,8	57,0	64,7	69,9	74,7	45,5	56,6	63,9	70,1	38,0	45,9	58,7	67,2	
0,20	54,6	61,9	67,2	71,9	58,5	65,9	71,1	75,8	47,6	58,2	65,4	71,4	39,7	47,4	60,6	68,4	
0,25	58,2	64,8	69,7	74,3	61,5	68,5	73,5	77,9	52,1	61,6	68,6	74,1	43,4	50,6	64,1	70,8	
0,37	63,9	69,5	73,8	78,1	66,0	72,7	77,3	81,1	59,7	67,6	73,5	78,0	49,7	56,1	69,3	74,3	
0,40	64,9	70,4	74,6	78,9	66,8	73,5	78,0	81,7	61,1	68,8	74,4	78,7	50,9	57,2	70,1	74,9	
0,55	69,0	74,1	77,8	81,5	70,0	77,1	80,8	83,9	65,8	73,1	77,2	80,9	56,1	61,7	73,0	77,0	
0,75	72,1	77,4	80,7	83,5	72,1	79,6	82,5	85,7	70,0	75,9	78,9	82,7	61,2	66,2	75,0	78,4	
1,1	75,0	79,6	82,7	85,2	75,0	81,4	84,1	87,2	72,9	78,1	81,0	84,5	66,5	70,8	77,7	80,8	
1,5	77,2	81,3	84,2	86,5	77,2	82,8	85,3	88,2	75,2	79,8	82,5	85,9	70,2	74,1	79,7	82,6	
2,2	79,7	83,2	85,9	88,0	79,7	84,3	86,7	89,5	77,7	81,8	84,3	87,4	74,2	77,6	81,9	84,5	
3	81,5	84,6	87,1	89,1	81,5	85,5	87,7	90,4	79,7	83,3	85,6	88,6	77,0	80,0	83,5	85,9	
4	83,1	85,8	88,1	90,0	83,1	86,6	88,6	91,1	81,4	84,6	86,8	89,5	79,2	81,9	84,8	87,1	
5,5	84,7	87,0	89,2	90,9	84,7	87,7	89,6	91,9	83,1	86,0	88,0	90,5	81,4	83,8	86,2	88,3	
7,5	86,0	88,1	90,1	91,7	86,0	88,7	90,4	92,6	84,7	87,2	89,1	91,3	83,1	85,3	87,3	89,3	
11	87,6	89,4	91,2	92,6	87,6	89,8	91,4	93,3	86,4	88,7	90,3	92,3	85,0	86,9	88,6	90,4	
15	88,7	90,3	91,9	93,3	88,7	90,6	92,1	93,9	87,7	89,7	91,2	92,9	86,2	88,0	89,6	91,2	
18,5	89,3	90,9	92,4	93,7	89,3	91,2	92,6	94,2	88,6	90,4	91,7	93,4	86,9	88,6	90,1	91,7	
22	89,9	91,3	92,7	94,0	89,9	91,6	93,0	94,5	89,2	90,9	92,2	93,7	87,4	89,1	90,6	92,1	
30	90,7	92,0	93,3	94,5	90,7	92,3	93,6	94,9	90,2	91,7	92,9	94,2	88,3	89,8	91,3	92,7	
37	91,2	92,5	93,7	94,8	91,2	92,7	93,9	95,2	90,8	92,2	93,3	94,5	88,8	90,3	91,8	93,1	
45	91,7	92,9	94,0	95,0	91,7	93,1	94,2	95,4	91,4	92,7	93,7	94,8	89,2	90,7	92,2	93,4	
55	92,1	93,2	94,3	95,3	92,1	93,5	94,6	95,7	91,9	93,1	94,1	95,1	89,7	91,0	92,5	93,7	
75	92,7	93,8	94,7	95,6	92,7	94,0	95,0	96,0	92,6	93,7	94,6	95,4	90,3	91,6	93,1	94,2	
90	93,0	94,1	95,0	95,8	93,0	94,2	95,2	96,1	92,9	94,0	94,9	95,6	90,7	91,9	93,4	94,4	
110	93,3	94,3	95,2	96,0	93,3	94,5	95,4	96,3	93,3	94,3	95,1	95,8	91,1	92,3	93,7	94,7	
132	93,5	94,6	95,4	96,2	93,5	94,7	95,6	96,4	93,5	94,6	95,4	96,0	91,5	92,6	94,0	94,9	
160	93,8	94,8	95,6	96,3	93,8	94,9	95,8	96,6	93,8	94,8	95,6	96,2	91,9	93,0	94,3	95,1	
200-1000	94,0	95,8	95,8	96,5	94,0	95,1	96,0	96,7	94,0	95,0	95,8	96,3	92,5	93,5	94,6	95,4	

60 Hz	P	Standard	High	Premium	Sup. Prem.	Standard	High	Premium	Sup. Prem.	Standard	High	Premium	Sup. Prem.	Standard	High	Premium	Sup. Prem.	
		kW	IE1	IE2	IE3	IE4	IE1	IE2	IE3	IE4	IE1	IE2	IE3	IE4	IE1	IE2	IE3	IE4
		0,12	57,5	59,5	62,0	66,0	62,0	64,0	66,0	70,0	48,0	50,5	64,0	68,0	36,0	40,0	59,5	64,0
0,18	62,0	64,0	65,6	70,0	66,0	68,0	69,5	74,0	52,5	55,0	67,5	72,0	40,0	46,0	64,0	68,0		
0,25	64,0	68,0	69,5	74,0	68,0	70,0	73,4	77,0	57,5	59,5	71,4	75,5	50,5	52,0	68,0	72,0		
0,37	70,0	72,0	73,4	77,0	70,0	72,0	78,2	81,5	62,0	64,0	75,3	78,5	57,5	58,0	72,0	75,5		
0,55	72,0	74,0	76,8	80,0	74,0	75,5	81,1	84,0	66,0	68,0	81,7	82,5	59,5	62,0	74,0	77,0		
0,75	74,0	75,5	77,0	82,5	77,0	78,0	83,5	85,5	72,0	73,0	82,5	84,0	64,0	66,0	75,5	78,5		
1,10	78,5	82,5	84,0	85,5	79,0	84,0	86,5	87,5	75,0	85,5	87,5	88,5	73,5	75,5	78,5	81,5		
1,50	81,0	84,0	85,5	86,5	81,5	84,0	86,5	88,5	77,0	86,5	88,5	89,5	77,0	82,5	84,0	85,5		
2,20	81,5	85,5	86,5	88,5	83,0	87,5	89,5	91,0	78,5	87,5	89,5	90,2	78,0	84,0	85,5	87,5		
3,70	84,5	87,5	88,5	89,5	85,0	87,5	89,5	91,0	83,5	87,5	89,5	90,2	80,0	85,5	86,5	88,5		
5,50	86,0	88,5	89,5	90,2	87,0	89,5	91,7	92,4	85,0	89,5	91,0	91,7	84,0	85,5	86,5	88,5		
7,50	87,5	89,5	90,2	91,7	87,5	89,5	91,7	92,4	86,0	89,5	91,0	92,4	85,0	88,5	89,5	91,0		
11	87,5	90,2	91,0	92,4	88,5	91,0	92,4	93,6	89,0	90,2	91,7	93,0	87,5	88,5	89,5	91,0		
15	88,5	90,2	91,0	92,4	89,5	91,0	93,0	94,1	89,5	90,2	91,7	93,0	88,5	89,5	90,2	91,7		
18,50	89,5	91,0	91,7	93,0	90,5	92,4	93,6	94,5	90,2	91,7	93,0	94,1	88,5	89,5	90,2	91,7		
22	89,5	91,0	91,7	93,0	91,0	92,4	93,6	94,5	91,0	91,7	93,0	94,1	90,2	91,0	91,7	93,0		
30	90,2	91,7	92,4	93,6	91,7	93,0	94,1	95,0	91,7	93,0	94,1	95,0	90,2	91,0	91,7	93,0		
37	91,5	92,4	93,0	94,1	92,4	93,0	94,5	95,4	91,7	93,0	94,1	95,0	91,0	91,7	92,4	93,6		
45	91,7	93,0	93,6	94,5	93,0	93,6	95,0	95,4	91,7	93,6	94,5	95,4	91,0	91,7	92,4	93,6		
55	92,4	93,0	93,6	94,5	93,0	94,1	95,4	95,8	92,1	93,6	94,5	95,4	91,5	93,0	93,6	94,5		
75	93,0	93,6	94,1	95,0	93,2	94,5	95,4	96,2	93,0	94,1	95,0	95,8	92,0	93,0	93,6	94,5		
90	93,0	94,5	95,0	95,4	93,2	94,5	95,4	96,2	93,0	94,1	95,0	95,8	92,5	93,6	94,1	95,0		
110	93,0	94,5	95,0	95,4	93,5	95,0	95,8	96,2	94,1	95,0	95,8	96,2	92,5	93,6	94,1	95,0		
150	93,0	95,0	95,4	95,8	93,5	95,0	96,2	96,5	94,1	95,0	95,8	96,2	92,5	93,6	94,5	95,4		
185-375	93,0	94,5	95,8	96,2	93,5	95,0	96,2	96,5	94,1	95,0	95,8	96,2	92,5	93,6	95,0	95,4		
375-1000	93,0	94,5	95,8	96,2	93,5	95,8	96,2	96,8	94,1	95,0	95,8	96,5	92,5	94,1	95,0	95,8		

1.1.4. Označavanje motora

Svaki motor označen je tipskom oznakom koja daje osnovne podatke o motoru u pogledu električne i mehaničke izvedbe. Tipaska oznaka sastoji se iz skupine slova i brojki čije je značenje određeno internim tvorničkim standardom.

1.1.4. Motors designation

Each motor is marked with type designation that contains basic data about motor related to electrical and mechanical construction. Type designation consists of group of letters and numbers whose meaning is determined by internal manufacturer's standard.

1.1.4. Motorenbezeichnung

Jeder Motor ist mit einer Typenbezeichnung verzeichnet, auf welcher die Grunddaten über den Motor im Hinblick auf die elektrische und mechanische Ausführung zu finden sind. Die Typenbezeichnung setzt sich aus Buchstaben und Zahlen zusammen und die Bedeutung ist durch den internen Firmenstandard bestimmt.

Tablica 1.3. / Table 1.3. / Tabelle 1.3.

A	B	C	D	E	F	G	H
E	5	AZ	KAE	100	LB	- 4	TAG

	Razjašnjenje	Description	Beschreibung
A	Učinkovitost	Efficiency	Effizienz
	bez oznake / without marking / kein Label - IE1 E - IE2 H - IE3 P - IE4		
B	Serijska 5 – aluminijsko kućište, Serijska 7 – kućište od sivog lijeva	Series 5 – aluminium housing Series 7 – cast iron housing	Typenreihe 5 – Aluminiumgehäuse Typenreihe 7 - Graugussgehäuse
C	Osnovna grupa	Base group	Basisgruppe
D	Dodatna opcije	Additional options	Zusätzliche Optionen
E	IEC veličina	IEC size	IEC Baugröße
F	Duljina paketa	Length of laminations	Blechkpaketlänge
G	Polaritet	Polarity	Polarität
H	Prigrađeni elementi i ostalo	Built in components and other	Eingebaute Komponenten und anderes

Pojašnjenje D / Explanation D / Erklärung D

K	kočnica	brake	Bremse
H	povećana snaga	increased power	progressive Leistung
A	spec. mehanička izvedba	special mechanical design	mechanische Sonderausführung
E	spec. električka izvedba	special electrical design	Elektrische Sonderausführung









Tablica 1.4. / Table 1.4. / Tabelle 1.4.

Standardni / standard				
Standardni / standard Normmotoren	AZ	asinkroni zatvoreni motori	<i>totally enclosed induction motors</i>	vollig geschlossener Asynchronmotor
	AZP	višebrzinski motori s konstantnim momentom	<i>multi – speed motors with constant torque at all speeds</i>	mehrtourige Motoren mit konstantem Moment auf allen Geschwindigkeiten
	AZPV	višebrzinski motori za ventilatorske pogone	<i>multi-speed motors for fans</i>	mehrtourige Motoren für Lüfterantriebe
	AZC	jednofazni motori s kondenzatorom za trajni rad	<i>single-phase capacitor run motors</i>	Einphasige Motoren mit dem Dauerbetriebskondensator
	AZCD	jednofazni motori s kondenzatorom za trajni rad i zaletnim kondenzatorom	<i>single-phase capacitor run/start motors</i>	Einphasige Motoren mit dem Anlauf- u. Dauerbetriebskondensator
	AZCS	jednofazni motori (u Steimnetz spoju)	<i>single phase motors in Steimnetz connection</i>	Einphasige Motoren in Steinmetz-Schaltung
Brodski / Marine / Marinemotoren	ABZ	AZ u brodskoj izvedbi	<i>AZ in marine design</i>	AZ in der Marineausführung
	ABZC	AZC u brodskoj izvedbi	<i>AZC in marine design</i>	AZC in der Marineausführung
	ABZCD	AZCD u brodskoj izvedbi	<i>AZCD in marine design</i>	AZCD in der Marineausführung
	ABZCS	AZCS u brodskoj izvedbi	<i>AZCS in marine design</i>	AZCS in der Marineausführung
	ABZP	AZP u brodskoj izvedbi	<i>AZP in marine design</i>	AZP in der Marineausführung
	ABZPV	AZPV u brodskoj izvedbi	<i>AZPV in marine design</i>	AZPV in der Marineausführung

Tablica 1.5. / Table 1.5. / Tabelle 1.5.

Pojašnjenje H / Explanation H / Erklärung H			
A	grijač	<i>winding heater</i>	Stillstandsheizung
G	enkoder	<i>encoder</i>	Impulsgeber
K	kabel	<i>cable</i>	Kabel
T	termička zaštita	<i>thermal protection</i>	thermischer Schutz
V	prisilno hlađenje	<i>forced cooling</i>	Fremdlüftung
Z	zaliven	<i>poured with resin</i>	vergossen
S	sklopka	<i>switch</i>	Schalter

Slika 1.2. / Picture 1.2. / Bild 1.2.

 KONČAR ZAGREB KONČAR - MES d.d. Croatia  Code 1204947 N° 123456 10/12 3 ~ Type 5AT 80B-4E/T4 IM B35 D/Y 230/400 V 50 Hz 3.3/1.9 A 0.75 kW 0.76 cosφ 1390 rpm 3xPTC T150 Ta 40 °C Cl. F IP55 S1 IEC/EN 60034	IE1 motori <i>IE1 motors</i> IE1 Motoren
 KONČAR ZAGREB KONČAR - MES d.d. Croatia  Code 1276131 N° 123456 10/12 440 kg 3 ~Mot E7AZ 250M-4T IM B3 Ta 40 °C IC 411 Cl. F Rise B IP 55 Hz kW V A cosφ rpm 50 55 D 400 98.5 0.86 1480 50 55 Y 690 57 0.86 1480 IE2-93.5% 3PTC T150 © DE/NDE 6314 2Z C3 S1 IEC 34, VDE0530	IE2 motori <i>IE2 motors</i> IE2 Motoren
 KONČAR ZAGREB KONČAR - MES d.d. Croatia  Code 1389761 N° 123456 10/12 3 ~ Type 5AZ 80B-4E/T4 IM B5 D/Y 230/400 V 50 Hz 3.3/1.9 A 0.75 kW 0.76 cosφ 1390 rpm UL E254469 Ta 40 °C Cl. F IP55 S1 IEC/EN 60034	Motori s UL brojem certifikata <i>Motors with UL certificate</i> Motoren mit dem UL-Zertifikat
 KONČAR ZAGREB KONČAR - MES d.d. Croatia  Code 1208306 N° 123456 10/12 250 kg 3 ~Mot 7AZ 200L-4T IM B3 Ta 40 °C IC 411 Cl. F Rise B IP 55 Hz kW V A Nm rpm 10 4.1 D 130 40 140 280 20 11.5 D 220 55 195 565 50 30 D 400 56 195 1465 87 30 D 400 57 110 2540 3PTC T150 © DE/NDE 6212 2Z C3 S1 IEC 34, VDE0530	motori s više napona i S9 pogonom <i>motors with multiple voltage and S9 duty</i> Mehrbereichsspannungsmotoren und in der S9 Betriebsart

1.2. Mehanička izvedba

1.2.1. Stupanj mehaničke zaštite – IP oznaka

Stupnjevi zaštite za mehaničke strojeve određeni su prema pravilima norme IEC 60034-5 s dva slova IP i dva karakteristična broja. Svi motori navedeni u ovom katalogu u osnovnoj izvedbi izvode se u stupnju zaštite IP 55. Ova zaštita štiti osobe od dodira dijelova pod naponom i od pokretnih unutarnjih dijelova, od štetnog taloženja prašine (prodor prašine nije u potpunosti spriječen, ali prašina ne može ući u dovoljnoj količini da utječe na rad stroja) i mlaza vode iz svih smjerova.

Na poseban zahtjev izrađuju se motori i u drugim stupnjevima zaštite.

Značenje pojedinih stupnjeva zaštite prikazano je u Tablici 1.6.

1.2. Mechanical features

1.2.1. Index of mechanical protection – IP code

Protection ratings for mechanical machines are defined in accordance with the rules of standard IEC 60034-5, with two letters IP and two characteristic numbers. All motors listed in this catalogue in basic design are produced in IP55 index of protection. This kind of protection protects persons from direct contact with parts under voltage and from direct contact with internal moveable parts, from harmful dust residues (dust breach is not totally blocked but dust cannot enter in sufficient mass to have influence in machine operation) and water from all directions.

Motors with other IP ratings are constructed upon special requests.

Meaning of respective IP ratings is presented in Table 1.6.

1.2. Mechanische Ausführung

1.2.1. Mechanische Schutzart – IP Zeichen

Die Schutzarten für elektrische Maschinen sind nach den Regeln der Norm IEC 60034-5 mit zwei Buchstaben IP und zwei charakteristischen Zahlen bestimmt. Alle in diesem Katalog genannten Motoren werden in ihrer Grundausführung in der Schutzart IP 55 ausgeführt. Dieser Schutz schützt die Personen von der Berührung der unter Spannung stehender Teile und von beweglichen Innenteilen, von schädlicher Staubablagerung (Eindringen des Staubs ist nicht vollständig verhindert, aber der Staub kann nicht in solcher Menge eindringen um die Arbeit der Maschine zu beeinflussen) und vom Wasserstrahl aus allen Richtungen.

Auf Anfrage können Motoren auch in anderen Schutzarten gebaut werden.

Die Bedeutung einzelner Schutzarten ist in der Tabelle 1.6. dargestellt.

Tablica 1.6. / Table 1.6. / Tabelle 1.6.

Zaštita električnih pogonskih sredstava od dodira stranih tijela i vode <i>Protection of electric drives from impact of water and foreign objects</i> Der Schutz elektrischer Antriebsmittel vom Fremdkörperberührung und Wasser			
Primjer: IP 5 5			
Oznaka slovima <i>Letter mark</i> Buchstabenbezeichnung		Zaštita od prodora stranih tijela i prašine (A) <i>Protection from dust breaches and foreign objects(A)</i> Schutz gegen Eindringen von Fremdkörper und Staub (A)	
		Zaštita od prodora vode (B) <i>Water protection (B)</i> Schutz gegen Eindringen des Wassers (B)	
A	Stupanj zaštite <i>Index of protection</i> Schutzstufe	B	Stupanj zaštite <i>Index of protection</i> Schutzstufe
4	Zaštita od zrnatih stranih tijela, d>1 mm, zaštita od alata, žica i sl. <i>Protection from small particles d>1 mm, protection from tools, wires etc</i> Schutz gegen körnige Fremdkörper mit d>1 mm, Schutz von Werkzeugen, Drähten und ähnlichem	4	Zaštita od prskajuće vode iz svih smjerova <i>Protection from splashing water from all directions</i> Schutz gegen Spritzwasser aus allen Richtungen
5	Zaštita od taloženja prašine (zaštićen od prašine), potpuna zaštita od dodira <i>Protection from residue of dust (dust protected), totally protected from impact</i> Schutz gegen Staubablagerung (staubgeschützt), voll-ständiger Berührungsschutz	5	Zaštita od mlaza vode iz svih smjerova <i>Protection from water jets from all directions</i> Schutz gegen Strahlwasser aus allen Richtungen
6	Zaštita od prodora prašine, (nepropusnost za prašinu), potpuna zaštita od dodira <i>Protection from dust residues (dust proof), totally protected from impact</i> Schutz gegen Eindringen des Staubs (staubdicht), vollständiger Berührungsschutz	6	Zaštita od zapljuskivanja morskom vodom ili jakog mlaza vode (zaštita od poplave) <i>Protection from splashing with seawater or strong water jet (flood protected)</i> Schutz gegen Aufschwemmen des Seewassers oder starken Wasserstrahls (flutgeschützt)
		7	Zaštita od uronjavanja u vodu pri određenim uvjetima tlaka i trajanja <i>Protection from immersing into a water at specific pressure and duration conditions.</i> Schutz gegen Eintauchen ins Wasser bei bestimmten Druck- u. Eintauchsbedingungen
		8	Zaštita od trajnog potapanja u vodu <i>Protection from permanent submersion in water</i> Schutz gegen dauerhafter Versenkung ins Wasser

1.2.2. Uvjeti okoline

Nazivne snage elektromotora u kontinuiranom pogonu (pogon S1) na temperaturama okoline -20°C do +40°C i visini od 1000 m n.v. su prikazani u tablici Tehnički podaci.

Naši motori su projektirani za temperaturnu klasu 155 (F) i korištenje u temperaturnoj klasi 130 (B). Motori mogu biti korišteni u temperaturnoj klasi 155(F) na 40°C sa servisnim faktorom 1.1 (motor može biti u konstantnom preopterećenju u iznosu 10% nominalnog).

Motori mogu podnijeti 1.5 puta veću struju od nazivne na nazivnom naponu i frekvenciji u periodu od dvije minute (EN 60034).

Ukoliko se uvjeti hlađenja promjene zbog povećanja temperature okoline ili povećanja visine, tada se mora promijeniti i nominalna snaga u skladu s korekcijskim faktorom u tablici 1.7.

1.2.2 Ambient conditions

Rated powers of electric motors in continuous operation, duty cycle type S1, at ambient temperatures between -20 and +40 °C and altitude of 1,000 m (ASL) are presented in tables Technical Data. Our motors are designed for temperature class 155 (F) and used in temperature class 130 (B). Motors can be used in temperature class 155 (F) at 40 °C with service factor 1.1 (the motor can be continuously overloaded with 10 % of the rated output). The motors can withstand 1.5 times the rated current at rated voltage and frequency for two minutes (EN 60034).

If cooling conditions are changed because of the rise of ambient temperature or increased altitude, than motor power must be corrected pursuant to Table 1.7.

1.2.2 Umgebungsbedingungen

Die Nennleistungen der Elektromotoren im Dauerbetrieb, Betriebsart S1, bei Umgebungstemperaturen von -20 bis +40 °C und auf der Höhe bis 1,000 m (über dem Meeresspiegel) sind in der Tabelle Technische Daten dargestellt. Unsere Motoren sind projektiert für die Temperaturklasse 155 (F) mit der Ausnutzung in der Temperaturklasse 130 (B). Die Motoren kann man in der Temperaturklasse 155 (F) auf 40 °C mit dem Servicefaktor 1.1 (der Motor kann sich kontinuierlich in der Überlastung in der Höhe von 10 % der Nennbelastung befinden). Die Motoren können mit einem 1.5 mal höheren Strom als der Nennstrom auf der Nennspannung- und Frequenz ist, im Zeitraum von zwei Minuten belastet werden (EN 60034). Im Falle, das sich die Kühlungsbedingungen wegen der Umgebungstemperaturerhöhung oder der Höhenlageänderung ändern, muss man den Leistungsfaktor im Einklang mit der Tabelle 1.7. auch ändern.

Tablica 1.7. / Table 1.7. / Tabelle 1.7.

Nadmorska visina Altitude (ASL) Meeresspiegelhöhe	Temperatura rashladnog zraka Cooling air temperature Kühllufttemperatur		
	40°C	50°C	60°C
1000	1	0,92	0,82
2000	0,94	0,86	0,77
3000	0,86	0,79	0,71
4000	0,77	0,71	0,63

Faktor snage u odnosu na nadmorsku visinu

Power factor in connection to altitude (ASL)

Leistungsfaktor in der Hinsicht auf den Meeresspiegelhöhe

1.2.3. Izolacijski sustav

Izolacijski sustav cjelokupnog osnovnog programa motora je izveden u toplinskoj klasi F. Standardno zagrijavanje motora je u toplinskoj klasi B, a na poseban zahtjev motori se izrađuju u toplinskoj klasi H.

Materijali koji se upotrebljavaju za izradu namota i u izolacijskom sustavu (žica, izolacijski materijali za utore i međuslojnu i međufaznu izolaciju, izvodi, navlake) su u minimalnoj klasi izolacije F. Impregnacija namota se provodi umakanjem u smolu. Impregnacijska smola koju koristimo je bezbojni poliesteramid temperaturnog indeksa 165°C i termičke klase F. S ovakvim postupkom osigurava se vrlo dobra ispunjenost među žicama u namotu. Otvrđivač za ovu smolu je stirol koji djeluje u procesu polimerizacije. Naš sustav impregnacije osigurava visok stupanj mehaničke i električne snage za dugi životni vijek motora.

Kada je motor predviđen za pogon preko pretvarača, izolacijski sustav je dodatno ojačan (ojačana izolacija u utorima, međufazna izolacija). Prema propisima IEC 60034-1 dopuštena zagrijavanja namota elektromotora, mjerena porastom otpora, za pojedine klase izolacije, uz temperaturu rashladnog zraka od 40°C, navedene su na slici 1.4.

1.2.3. Insulation system

Insulation system of the whole basic program is made in thermal class F. Standard motor temperature rise is in thermal class B and on special request motors are produced in thermal class H upon special requests.

Materials used for coils production and for insulation system (wire, slot insulation material, between layer and between phase insulation, leads, protective tubes) are within minimal insulation class F.

Winding impregnation is performed in impregnation facility with immersion in resin. Impregnation resin which we use is non saturated polyesteramide of temperature index 165 °C and thermal class "F". With such a procedure the very good filling and cohesion between the winding wires is assured. Hardener for this resin is styrol that acts in polymerization process. Our impregnation system ensures a high level of mechanical and electrical strength for a long motor life.

When motor is made to be driven with frequency converter insulation system is additionally strengthened (increased slot insulation, inter-phase insulation,...).

According to directive IEC 60034-1, allowed temperature rise of motor winding, measured by increasing of resistance, for individual insulation classes, by temperature of cooling air of 40°C, has the values give in the Picture 1.4.

1.2.3. Isolationssystem

Das Isolationssystem des gesamten Grundprogramms der Motoren ist in der Temperaturklasse F ausgeführt. Die Standardaufwärmung der Motoren ist in der Temperaturklasse B und auf Sonderanfrage fertigt man die Motoren in der Temperaturklasse H.

Die für die Wicklungsfertigung und im Isolationssystem verwendeten Materialien (Draht, Nutilation, Zwischenschicht- u. Phasenisolation, Ausführungen, Schläuche) sind mindestens in der Isolationsklasse F.

Wicklungsimpregnierung erfolgt in der Impregnierungsanlage mittels eintauchen in den Harz. Der Tränkharz, welchen wir benutzen ist ein farbloses ungesättigtes Polyesterimid der Temperaturindex 165 °C und der Temperaturklasse „F“. Mit diesem Verfahren sichert man eine sehr gute Ausfüllung und Kohäsion zwischen den Wicklungsdrähten. Der Härter dieses Harzes ist Styrol welcher während des Polymerisationsprozesses wirkt. Unseres Impregnierungssystem sichert eine hohe mechanische und elektrische Festigkeit für einen langen Motorlebensdauer.

Wenn der Motor für den FU-Betrieb bestimmt ist, wird das Isolationssystem zusätzlich gestärkt (verstärkte Nuten- und zwischenphasenisolation).

Die nach den IEC 60034-1 Vorschriften zugelassenen Wicklungserwärmungen der Elektromotoren, gemessen durch Widerstandserhöhung, für die einzelnen Isolationsklassen bei der Kühllufttemperatur von 40°C, sind in der Bild 1.4. angegeben:

Slika 1.4. / Picture 1.4. / Bild 1.4.

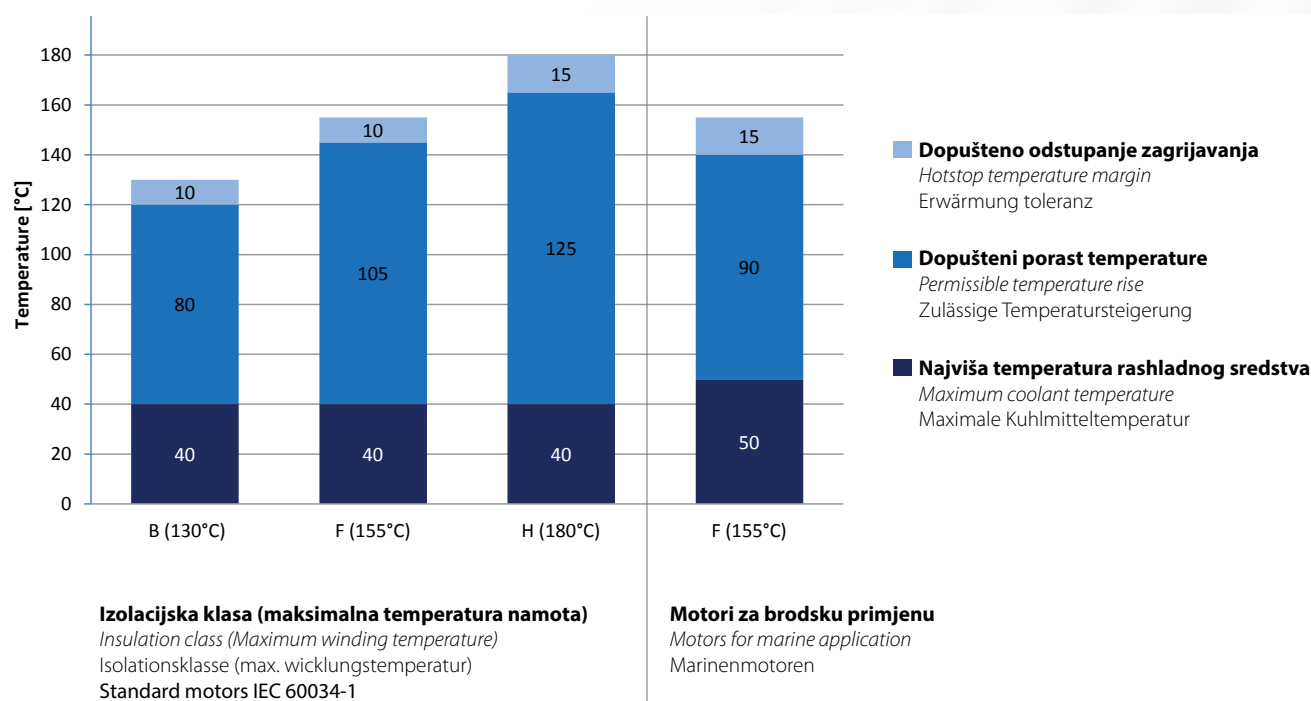

Na poseban zahtjev izolacijski sustav može biti izveden za specijalne uvjete rada, npr.:

- Tropski izolacijski sustav za motore koji rade u prostorima s tropskom klimom ili u prostorima u kojima dolazi do čestih promjena temperature i vlažnosti te kondenziranja vodene pare. Motori koji se transportiraju preko tropskih krajeva također moraju biti izvedeni s tropskom izolacijom. Protiv gljivica i insekata, unutrašnji dijelovi motora zaštićeni su antifungicidnim lakovima.
- Izolacijski sustav otporan na povećanu vlažnost za motore koji rade u praonicama, šećerana, mljekarana, na otvorenom i na ostalim mjestima s visokom relativnom vlagom u zraku.
- Izolacijski sustav otporan na kemikalije za motore koji rade u prostoru s kemijski agresivnim plinovima i parama te općenito u kemijskoj industriji.
- Izolacijski sustav otporan na ulje za specijalne motore koji rade potopljeni u ulje.
- Izolacijski sustav otporan na vibracije za motore koji rade u pogonima podložnim vibracijama kao npr.: kompresori, pogoni bagera te pogoni na tračnim vozilima.
- Projektiranje motora sa zagrijavanjem u toplinskoj klasi B i upotreba kvalitetnih materijala za namot i izolacijski sustav osiguravaju dugotrajnu pouzdanost naših motora.

Odgovarajući uvjeti rada moraju biti jasno iskazani u narudžbi.

Na zahtjev izolacijski sustav može biti izveden i u skladu s UL direktivama za američko i kanadsko tržište prema certificiranom izolacijskom sustavu KONČAR-MES 155 (UL oznaka E254469).

On request, insulation system can be made for special working conditions, e.g.:

- *Tropical insulation system for motors that are operated in tropical environment or in environment with sudden changes of temperature and humidity and accompanied by vapour condensation. Motors, which are transported over territories with tropical climate, must be made with tropical insulation too. Inner motor parts are protected against fungus and insects by means of nonfungicide lacquer.*
- *High humidity resistant insulation system for motors operating in wash houses, sugar plants, dairy plants, in the open air and at all other places with high relative air humidity.*
- *Chemicals resistant insulation system for motors operating in area with chemically aggressive gases and vapours and generally in chemical industry.*
- *Oil resistant insulation system for special motors operating immersed in oil.*
- *Vibration resistant insulation system for motors operated in facilities exposed to vibrations, e.g. compressors, dredger drives or tracks vehicle drives.*
- *Motor design with temperature rise in thermal class B and usage materials of good quality for winding and insulation system provide long time reliability of our motors.*

Adequate working conditions must be clearly defined in the order.

On request, insulation system can be made in accordance with UL directives for USA and Canadian market according to certified insulation system KONČAR-MES 155 (UL mark E254469).

Auf Anfrage kann das Isolationssystem für besondere Arbeitsbedingungen ausgeführt werden, z.B.:

- Das Tropenisolationssystem für die Motoren, die in den Gebieten mit tropischem Klima betrieben werden oder solchen wo die Temperatur- u. Luftfeuchtigkeitsänderungen sowie Wasserdampfkondensation oft vorkommen. Die Motoren, die durch tropische Gebiete transportiert werden, müssen auch mit der Tropenisolierung ausgeführt sein. Gegen Pilze und Insekten sind die Motorenteile mit Antifungizidlacken geschützt.
- Das Isolationssystem beständig gegen erhöhte Feuchtigkeit für die Motoren, die in Waschräumen, Zuckerfabriken, Molkereien, im Freien und in anderen Gebieten mit hoher Luftfeuchtigkeit betrieben werden.
- Das Isolationssystem beständig gegen Chemikalien für die Motoren, die in Gebieten mit chemisch aggressiven Gasen und Dämpfen sowie allgemein in chemischer Industrie betrieben werden.
- Das Isolationssystem beständig gegen Öl für die Motoren, die ins Öl eingetaucht betrieben werden.
- Das Isolationssystem beständig gegen Vibrationen für die Motoren, die beim Betrieb Vibrationen ausgesetzt sind wie z.B. im Kompressoren, Baggern und Schienenfahrzeugen.
- Die Projektierung der Motore mit der Erwärmung in der Temperaturklasse B und Verwendung wertvoller Werkstoffe für die Wicklung und das Isolationssystem sichern dauerhafte Verlässlichkeit unserer Motoren.

Entsprechende Arbeitsbedingungen müssen deutlich in der Bestellung angedeutet sein.

Auf Anfrage kann das Isolationssystem auch im Einklang mit UL-Richtlinien für den amerikanischen und kanadischen Markt nach zertifiziertem Isolationssystem KONČAR-MES 155 (UL mark E254469) ausgeführt sein.

Slika 1.5. / Picture 1.5. / Bild 1.5.



 **ONLINE CERTIFICATIONS DIRECTORY**

OBJY2.E254469
Systems, Electrical Insulation - Component

Systems, Electrical Insulation - Component

[See General Information for Systems, Electrical Insulation - Component](#)

KONCAR - MES D D E254469
FALLEROVO SETALISTE 22
10000 ZAGREB, CROATIA

Class 155 (F) insulation system, designated Koncar - MES 155.

Marking: Company name and system designation.

[Last Updated](#) on 2005-09-23

1.2.4. Vrste pogona

Standardna izvedba motora je prilagođena za normalan kontinuiran pogon i normalne uvjete rada, tj. S1 – trajni pogon s konstantnim opterećenjem. U Tablici 1.8. opisane su ostale vrste pogona.

1.2.4. Type of duty cycles

Standard motor design is adjusted for normal continuous drive and normal working conditions, i.e. S1 – continuous duty with constant load. All other duty cycle types are described in Table 1.8.

1.2.4. Betriebsarten

Die Standardmotorausführung ist für den normalen kontinuierlichen Betrieb und normalen Arbeitsbedingungen angepasst, d.h. S1- Dauerbetrieb mit konstanter Belastung. In der Tabelle 1.8. sind die anderen Betriebsarten beschrieben.

Tablica 1.8. / Table 1.8. / Tabelle 1.8.

	Trajni pogon	Continuous duty	Dauerbetrieb
<p>S1</p>	<p>Rad pod konstantnim opterećenjem. Stroj se zagrije do maksimalne temperature, koja tada postaje trajnom konačnom temperaturom.</p>	<p><i>Operating under constant load. Machine is warmed up to maximum temperature, which then becomes permanent end temperature.</i></p>	<p>Der Betrieb unter konstanter Belastung. Die Maschine erwärmt sich bis zur maximalen Temperatur welche dann dauerhafte Endtemperatur wird.</p>
<p>S2</p>	<p>Kratkotrajni pogon gdje se konačna temperatura ne postiže. Pauza koja slijedi dovoljna je za ohlađivanje.</p>	<p><i>Short-time duty cycle where end temperature is not reached. The following interval is enough for cooling.</i></p>	<p>Der Kurzzeitbetrieb bei welchem die Endtemperatur nicht erreicht wird. Die nachfolgende Pause genügt für die Abkühlung.</p>
<p>S3</p>	<p>Pogon je sastavljen od niza istovrsnih ciklusa koji se sastoje od pogona s konstantnim opterećenjem i mirovanja.</p>	<p><i>Duty cycle is composed of uniform series of cycles that consist of constant load duty and a standstill.</i></p>	<p>Der Betrieb ist zusammengesetzt aus einer Reihe gleichwertiger Zyklen, welche aus dem Betrieb mit konstanter Belastung und Stillstand bestehen.</p>
<p>S4</p>	<p>Pogon je sastavljen od niza istovrsnih ciklusa koji se sastoje od vremena zaleta, pogona s konstantnim opterećenjem i mirovanja.</p>	<p><i>Duty cycle is composed of uniform series of cycles which consist of starting time, constant load duty and a standstill.</i></p>	<p>Der Betrieb ist zusammengesetzt aus einer Reihe gleichwertiger Zyklen, welche aus der Anlaufzeit, dem Betrieb mit konstanter Belastung und dem Stillstand bestehen.</p>
<p>S5</p>	<p>Istovrsni ciklusi sastoje se od vremena zaleta, vremena s konstantnim teretom i vremena kočenja.</p>	<p><i>Uniform cycles consisting of starting time, constant load time and braking time.</i></p>	<p>Die gleichwertigen Zyklen sind aus der Anlaufzeit, Zeit mit der konstanten Last und der Bremszeit zusammengesetzt.</p>

<p>S6</p>	<p>Trajni pogon s isprekidanim opterećenjem</p> <p>Istovrsni ciklusi sastoje se od vremena s konstantnim opterećenjem i vremena praznog hoda.</p>	<p><i>Continuous duty cycle with intermittent load</i></p> <p><i>Uniform duty cycles consisting of constant load time and idling (no load time).</i></p>	<p>Dauerbetrieb mit Aussetzbelastung</p> <p>Die gleichwertigen Zyklen sind aus der Zeit mit konstanter Belastung und Leerlaufzeit zusammengesetzt.</p>
<p>S7</p>	<p>Neprekidni pogon sa zaletom i električnim kočenjem</p> <p>Istovrsni ciklusi sastoje se od vremena zaleta pogona s konstantnim opterećenjem i vremena kočenja.</p>	<p><i>Continuous duty cycle with starting and electrical braking</i></p> <p><i>Uniform duty cycles consisting of starting time, constant load time, and braking time.</i></p>	<p>Nichtaussetzbetrieb mit Anlauf und elektrischer Bremsung</p> <p>Die gleichwertigen Zyklen sind aus der Antriebsanlaufzeit mit konstanter Belastung und Bremszeit zusammengesetzt.</p>
<p>S8</p>	<p>Neprekidni pogon s periodičkom promjenom brzine vrtnje</p> <p>Svaki ciklus sadrži vrijeme s konstantnim opterećenjem i određenom brzinom vrtnje, zatim jedno ili više vremena s drugim opterećenjem kojima odgovaraju različite brzine vrtnje.</p>	<p><i>Continuous duty cycle with periodical change of revolving speed</i></p> <p><i>Each duty cycle includes time with constant load and determined revolving speed, than one or more times with different loads which match different revolving speeds.</i></p>	<p>Nichtaussetzbetrieb mit periodischer Drehgeschwindigkeitsänderung</p> <p>Jeder Zyklus beinhaltet die Zeit mit konstanter Belastung und bestimmter Drehgeschwindigkeit, nachfolgend eine oder mehrere Zeiten mit anderer Belastung welchen verschiedene Drehgeschwindigkeiten entsprechen.</p>
<p>S9</p>	<p>Isprekidan pogon s neperiodičkim promjenama opterećenja i brzine</p> <p>Pogon je sastavljen od niza neperiodičkih ciklusa, gdje je promjenjivo opterećenje i brzina. Karakterističan pogon preko frekvencijskog pretvarača.</p>	<p><i>Intermittent duty cycle with non-periodical changes of load and revolving speed</i></p> <p><i>Duty cycle is consisting of series of non-periodical cycles, with changable load and revolving speed. Characteristic duty cycle for drive through frequency inverter.</i></p>	<p>Aussetzbetrieb mit nichtperiodischer Belastungs- u. Geschwindigkeitsänderungen</p> <p>Der Betrieb ist aus einer Reihe nichtperiodischer Zyklen zusammengesetzt, wo die Belastung und Geschwindigkeit änderbar sind. Charakteristischer Antrieb über den Frequenzumrichter.</p>
<p>S10</p>	<p>Trajni pogon s karakterističnim promjenjivim opterećenjem</p> <p>Kontinuiran rad s promjenjivim opterećenjem. Pogon je sastavljen od niza ciklusa promjenjivog vremena opterećenja. Stroj se zagrijava na različite temperature ovisne o opterećenju. Pogon sadrži maksimalno 4 karakteristične vrijednosti opterećenja u dovoljnom trajanju da se dosegne termička ravnoteža stroja. Minimalno opterećenje tijekom radnog ciklusa može biti 0, tj. bez opterećenja.</p>	<p><i>Continuous duty cycle with characteristic changeable load</i></p> <p><i>Continuous operation with changeable load. Duty cycle consists of series of changeable load timecycles. Machine is warmed up to different temperatures, depending on load. Duty cycles have max. 4 characteristic load values long enough to reach thermal machine balance. Minimal load during working cycle can be 0, i.e. with no load at all.</i></p>	<p>Dauerbetrieb mit charakteristisch sich ändernder Belastung</p> <p>Kontinuierlicher Betrieb mit ändernder Belastung. Der Betrieb ist aus einer Zyklusreihe änderbarer Belastungszeit zusammengesetzt. Das Gerät wird zu bestimmten von der Belastung abhängigen Temperaturwerten erwärmt. Der Betrieb hat höchstens 4 charakteristische Belastungswerte in einer Dauer, die genügt das thermische Gleichgewicht zu erreichen. Die minimale Belastung während des Betriebszyklus kann den Wert 0 haben, d.h ohne Belastung.</p>

1.2.5. Izvedbeni oblici

Izvedbeni oblici motora i njihovo označavanje definirani su propisima IEC 60034-7. U Tablici 1.9. prikazani su izvedbeni oblici s usporednim oznakama prema DIN i prema IEC.

1.2.5. Mounting arrangements

Mounting arrangements and their marking are defined by directives IEC 60034-7. Mounting arrangements with markings according to DIN and IEC are given in the Table 1.9.

1.2.5. Bauformen

Die Bauformen der Motoren und deren Bezeichnungen sind mit Vorschriften IEC 60034-7. In der Tabelle 1.9. sind die Bauformen mit vergleichenden Bezeichnungen nach DIN und IEC dargestellt.

Tablica 1.9. / Table 1.9. / Tabelle 1.9.

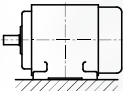
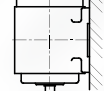
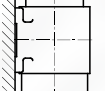
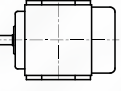
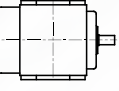
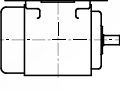
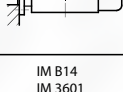
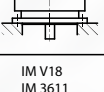
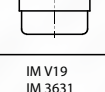
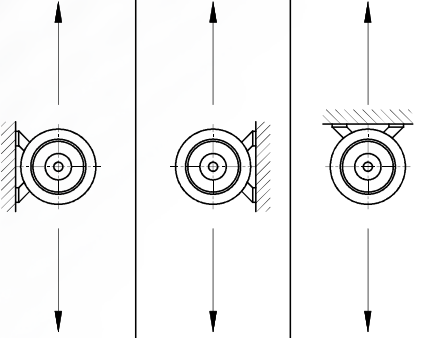
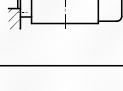
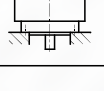
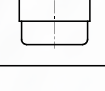
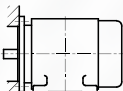
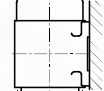
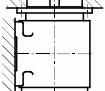
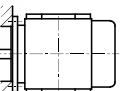
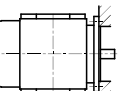
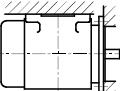
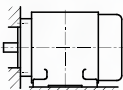
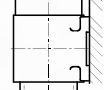
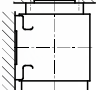
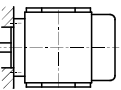
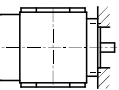
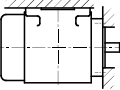
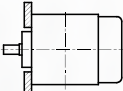
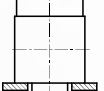
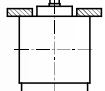
<p>IM B3 IM 1001</p> 	<p>IM V5 IM 1011</p> 	<p>IM V6 IM 1031</p> 	<p>IM B6 IM 1051</p> 	<p>IM B7 IM 1061</p> 	<p>IM B8 IM 1071</p> 
<p>IM B5 IM 3001</p> 	<p>IM V1 IM 3011</p> 	<p>IM V3 IM 3031</p> 			
<p>IM B14 IM 3601</p> 	<p>IM V18 IM 3611</p> 	<p>IM V19 IM 3631</p> 			
<p>IM B35 IM 2001</p> 	<p>IM V15 IM 2011</p> 	<p>IM V36 IM 2031</p> 	<p>IM 2051</p> 	<p>IM 2061</p> 	<p>IM 2071</p> 
<p>IM B34 IM 2101</p> 	<p>IM V15 IM 2111</p> 	<p>IM V36 IM 2131</p> 	<p>IM 2151</p> 	<p>IM 2161</p> 	<p>IM 2171</p> 
<p>IM B9 IM 9101</p> 	<p>IM V8 IM 9111</p> 	<p>IM V9 IM 9131</p> 	<p>Prema IEC 60034-7 i DIN 49250 According to IEC 60034-7 and DIN 49250 Nach IEC 60034-7 und DIN 49250</p>		

Motor montiran nogama

Foot mounted motor

Fussmotor

Motor montiran prirubnicom s provrtima na pogonskoj strani

Flange mounted motor with through holes at D-end

Flanschmotor mit Durchgangslöcher antriebsseitig

Motor montiran prirubnicom s navojnim uvrtima na pogonskoj strani

Flange mounted motor with blind tapped holes at D-end

Flanschmotor mit blinden Gewindelöcher antriebsseitig

Motor montiran nogama i prirubnicom s provrtima na pogonskoj strani

Foot and flange mounted motor with through holes at D-end

Fuss-und Flanschmotor mit Durchgangslöcher antriebsseitig

Motor montiran nogama i prirubnicom s navojnim uvrtima na pogonskoj strani

Foot and flange mounted motor with blind tapped holes at D-end

Fuss-und Flanschmotor mit blinden Gewindelöcher antriebsseitig

Motor bez ležaja i ležajnog štita na pogonskoj strani

Motor without bearing and endshield on D-end

Motor ohne Lager und Lagerschild antriebsseitig

1.2.6. Mehanička izvedba

Konstrukcija kućišta, priključne kutije i ležajnih štitova

Kućište i ležajni štitovi su napravljeni:

- Serija 5: aluminij
- Serija 7: sivi lijev

Ostale varijante konstrukcije kućišta, priključnih kutija i ležajnih štitova su dostupni prema zahtjevu.

Ventilatori i ventilatorske kape

Motore u standardnoj verziji imaju ventilatore s radialnim protokom koji su montirani na vratilo na SS strani (metoda hlađenja IC411 prema IEC 60034-6). Standardni ventilator za seriju 5 je izveden od plastike, a za seriju 7 je napravljen od aluminija. Prema zahtjevu kupca, u mogućnosti smo izvesti ventilator na seriji 5 od aluminija, a u seriji 7 od čelika.

Motore su također dostupni u verziji s neovisno pogonjenim ventilatorom (metoda hlađenja IC 416). Standardni napon za motore u prisilnom hlađenju je: D230 V/Y400 V $\pm 10\%$, 50 Hz.

Ventilator je prekriven limenom zaštitnom kapom. Ostali oblici konstrukcije ventilatorske kape (kapa protiv kiše - karniti, kapa za tekstilnu industriju...) su dostupni na zahtjev.

1.2.6 Mechanical design

Design of frame, terminal box and bearing shields
The frame and bearing shield is made:

- series 5: aluminum
- series 7: cast iron

Other design of frames, terminal box and bearing shield are available on request.

Fans and fan cover

Motors have radial flow fans in the standard version mounting on NDE shaft (cooling method IC 411 acc. to IEC 60034-6). The standard fan impeller for series 5 is made of plastic and for series 7 is made of aluminium. On request for series 5 are available fan impeller made of aluminium and for series 7 are available fan impeller made of steel.

Motors are also available in a version with a separately driven fan (cooling method IC 416). Standard supply voltages for separately driven fans: D230 V/Y400 VY $\pm 10\%$, 50 Hz.

Fan is covered with sheet metal fan cover. Other design of fan cover (rain fan cover, for textile industry, ...) are available on request.

1.2.6. Mehanische Ausführung

Konstruktion der Gehäuse, des Klemmkastens und der Lagerschilder

Die Gehäuse und die Lagerschilder sind gemacht aus dem:

- Aluminium (Typenreihe 5)
- Grauguss (Typenreihe 7)

Andere Konstruktionsvarianten der Gehäuse, der Klemmkasten und der Lagerschilder sind auf Anfrage erhältlich.

Lüfterräder und Lüfterhauben

Die Motoren der Standardausführung besitzen die Lüfterräder mit radialem Luftdurchsatz, welche sich auf der nichtantriebsseitiger Wellenseite (Kühlungsart IC411 nach IEC 60034-6) befinden. Standardmässiger Lüfterrad für die Typenreihe 5 ist aus dem Kunststoff und für die Typenreihe 7 aus dem Aluminium. Nach Kundenanfrage sind wir in der Möglichkeit das Lüfterrad in der Typenreihe 5 aus dem Aluminium und in der Typenreihe 7 aus dem Stahl. Zufertigen Die Motoren sind auch erhältlich in der Version mit der Fremdlüftung (Kühlungsart IC416). Standardmässige Spannung für die Fremdlüftungsmotoren beträgt D230V/Y400V $\pm 10\%$, 50 Hz. Der Fremdlüfter ist mit der Blechschutzhäube bedeckt. Andere Konstruktionsbauformen der Lüfterhaube (Regenschutzdach, Textilhaube...) sind auf Anfrage erhältlich.

1.2.7. STUPANJ MEHANIČKE ZAŠTITE – IK oznake

Klasifikacija stupnjeva zaštite kućišta za motore protiv vanjskih mehaničkih udara, su definirani prema pravilima standarda EN 62262 s dva slova IK i dva karakteristična broja. Svi motori prikazani u ovom katalogu u osnovnoj izvedbi su proizvedeni s IK 08 indeksom zaštite. Svi dijelovi za zatvaranje motora su testirani udarnim testom energijom od 5 Joula.

Motori s drugim stupnjem IK zaštite se mogu napraviti prema zahtjevu kupca.

Značenje IK oznake je prikazano u tablici 1.10.

1.2.7. Degree of mechanical protection – IK code

Classification of degrees of protection by enclosure for motors against external mechanical impacts are defined in accordance with the rules of standard EN 62262 with two letters IK and two characteristic numbers. All motors listed in this catalogue in basic design are produced in IK 08 index of protection. All enclosure – parts of motors are tested with impact test energy 5 Joule.

Motors with other IK code are constructed upon special requests.

Meaning of respective IK code is presented in Table 1.10.

1.2.7. Die Stufe des mechanischen Schutzes – IK Kodierung

Die Klassifizierung der Schutzstufen durch das Gehäuse gegen äußere mechanische Schläge sind definiert nach der Regelung der Norm EN 62262 mit zwei Buchstaben IK und zwei charakteristischen Ziffern. Alle Motoren standardmäßiger Ausführung dargestellt in diesem Katalog sind mit dem IK 08 Schutzindex gefertigt. Alle abdeckende Motorteile sind einer Schlagprüfung mit der Energie von 5 Joule ausgesetzt. Die Motoren mit einem anderen IK Schutzindex kann man auf Sonderkundenanforderung konstruiert werden. Die Bedeutung der IK Bezeichnung ist in der Tabelle 1.10. dargestellt.

Tablica 1.10. / Table 1.10. / Tabelle 1.10.

IK	8
Međunarodna mehanička zaštita <i>International mechanical protection</i> Internationale mechanische Schutzart	Grupa karakteristika <i>Characteristics group</i> Die Gruppe der Charakteristiken

Veza između IK koda i udarne energije / Relation between IK code and impact energy / Verhältnis zwischen der IK Kodierung und der Aufschlagenergie											
IK kod / IK Code / IK Kodierung	IK 0	IK 01	IK 02	IK 03	IK 04	IK 05	IK 06	IK 07	IK 08	IK 09	IK 10
Udarne energija [J] <i>Impact energy [J]</i> Aufschlagenergie	-	0,15	0,2	0,35	0,5	0,7	1	2	5	10	20

1.2.8. Vratilo

Zavisno o nazivnim karakteristikama motora, dimenzije vratila su prilagođene veličinama motora. Motorska vratila od specijalnog čelika ili specijalnih dimenzija su dostupna na zahtjev. Dimenzije i tolerance za klinove i utore klinova su prema EN 50347.

1.2.8. Shaft

Depending on the rated output the output shaft are assign to the frame sizes. Motor shafts of special steel or dimensions are available on request. Dimensions and tolerances for keyways and keys are designed according to EN 50347.

1.2.8. Welle

Abhängig von der Nennausgangscharakteristiken des Motors sind die Wellendimensionen der Motorbaugrößen zugeordnet. Die Motorwellen aus dem Sonderstahl oder mit den Sondermassen sind auf Anfrage erhältlich. Die Massen und Toleranzen für Passfedernuten und Passfeder sind nach EN 50347.

1.2.9. Ležajevi

Motori veličina 56 do 250 imaju trajno podmazane ležajeve. Od veličine 280 na više, motori imaju ležajeve s ugrađenim mazalicama. Intervali za podmazivanje, količina maziva i tip maziva su definirani na dodatnoj pločici elektromotora. Kotrljajući ležajevi za teške pogone na prednjoj strani motora (za povećana radijalna opterećenja) i dodatni tipovi mazalica su dostupni na zahtjev. Preporuča se koristiti kotrljajuće ležajeve na motorima koji prenose gibanje remenicom na veličinama od 132 do 315.

1.2.9. Bearings

The motor frame sizes 56–250 have permanent grease lubricated anti-friction bearings. From frame size 280 the motors have regreasing devices. Regreasing intervals, quantity of grease and grade of grease are marked on an auxiliary plate on the motor. Heavy-duty roller bearing arrangements at drive end for increased radial load and regreasing devices are available on request. It is recommended to use roller bearings in belt drives for motor sizes 132 - 315.

1.2.9. Lager

Die Motorenbaugrößen 56 bis 250 haben dauergeschmierte Lager. Ab Baugröße 280 nach oben haben die Motoren eingebaute Schmiernippel. Die Nachschmierintervalle, Fettmenge und Fettart sind auf zusätzlichem Motorschild definiert. Die Walzrollenlager für schwere Antriebe auf der Antriebsseite des Motors (für erhöhte Radialbelastungen) und zusätzliche Nachschmiereinrichtungen sind auf Anfrage erhältlich. Man schlägt vor die Rollenlager für Riemenantriebe auf den Motorbaugrößen 132 bis 315 zu verwenden.

Tablica 1.11. / Table 1.11. / Tabelle 1.11.

IEC	Serija 5AZ/7AZ / Series 5AZ/7AZ / Baureihe 5AZ/7AZ	
	Tip ležaja na PS / SS strani Bearing type on DE/NDE Lagertyp auf AS/BS	Oznaka brtvila / Labirintnog prstena na PS/SS strani Oil seal type/labyrinth ring on DE/NDE WDR / Labyrinthdichtung Type auf AS/NAS
56	6201 – 2RS C3	A12 x 22 x 6
63	6202 – 2RS C3	A15 x 25 x 5
71	6203 – 2RS C3	A17 x 28 x 7
80	6204 – 2RS C3	A20 x 35 x 7
90	6205 – 2RS C3	A25 x 37 x 7
100	6206 – 2RS C3	A30 x 47 x 7
112	6306 – 2RS C3	A30 x 47 x 7
132	6208 – 2Z C3	A40 x 55 x 7
160	6309 – 2Z C3	A45 x 60 x 7
180	6310 – 2Z C3	A50 x 65 x 8
200	6312 – 2Z C3	A60 x 80 x 10
225	6313 – 2Z C3	A65 x 85 x 10
250	6314 – 2Z C3	A70 x 90 x 10
280	6316 – C3	A80 x 115 x 12
315	6319- C3	A85 x 115 x 13

1.2.10. Dozvoljene radijalne i aksijalne sile

Pod prosječnim uvjetima uporabe, životni vijek (Lh10) od 100.000 sati može biti dostignut. Životni vijek ležajeva ovisi o različitim faktorima kao što je veličina ležajeva, opterećenje, brzina motora, uvjeti uporabe i životnom vijeku maziva. Životni vijek ležajeva na motorima s horizontalnim tipom konstrukcije je najmanje 40.000 sati ako ne postoji dodatna aksijalna sila i najmanje 25.000 sati s dozvoljenim aksijalnim naprezanjem.

Dozvoljene radijalne sile u Njutnima (podrazumjevajući nepostojanje aksijalne sile) i aksijalne sile u Njutnima (podrazumjevajući nepostojanje radijalne sile) za različite veličine motora su prikazane u tablici 1.13.

Vrijednosti su bazirane na normalne uvjete na 50Hz sa standardnim ležajevima i životnim vijekom od 25.000 sati.

Na 60 Hz vrijednosti su smanjene za 15%. Za višebrzinske motore, vrijednosti su bazirane na većoj brzini.

Dopuštena aksijalna opterećenja (FA) na slobodni kraj vratila (u N) za standardni način uležištenja obzirom na položaj ugradnje te smjer djelovanja opterećenja data su u Tablici 1.13.

Dopušteno radijalno opterećenje (FR) na slobodni kraj vratila (u N) za standardni način uležištenja i hvatište $X = E/2$ (mm) neovisno o položaju ugradnje motora dano je u Tablici 1.13. Dozvoljena istovremena opterećenja aksijalnim i radijalnim silama su dostupna na zahtjev.

1.2.10. Permissible radial and axial forces

Under average operating conditions, a lifetime (Lh10) of 100,000 hours can be achieved. The lifetime of bearings is dependent on various factors such as bearing size, bearing load, motor speed, operating conditions and the grease lifetime. The bearing lifetime of motors with horizontal type of construction is at least 40,000 hours if there is no additional axial loading and at least 25000 hours with the admissible permitted loads.

The permissible radial forces in Newton (assuming zero axial force) and axial forces in Newton (assuming zero radial force) for different motor sizes is shown in the table 1.13. on the following pages. The values are based on normal conditions at 50 Hz with standard bearings and calculated bearing of 25000 hours.

At 60 Hz the values are to be reduced by 15%. For two-speed motors, the values are to be based on the higher speed.

Permissible axial loads (FA) on free shaft end (in N) for standard bearing assembly in relation with mounting arrangement and direction of load according to are given in the tables 1.13.

Permissible radial loads (FR) on free shaft end (in N) for standard bearing assembly and point application of the force $X = E/2$ (mm) independent of motor mounting arrangement are given in Table 1.13.

The permissible loads of simultaneous radial and axial forces are available on request.

1.2.10. Zulässige Radial- und Axialkräfte

Unter durchschnittlichen Einsatzbedingungen kann die Lebensdauer (Lh10) von 100.000 Stunden erreicht werden. Die Lagerlebensdauer ist von verschiedenen Faktoren, wie z.B. Lagergröße, Belastung, Drehgeschwindigkeit, Einsatzbedingungen und Fettlebensdauer sind, abhängig. Die Lagerlebensdauer auf der Motoren, die für horizontale Einbaulage konstruiert sind beträgt mindestens 40.000 Stunden wenn keine zusätzliche Axialkraft vorhanden ist und mindestens 25000 Stunden mit zulässiger Axialbelastung. Zulässige Radialkräfte in Newton (vorausgesetzt es ist keine Axialkraft vorhanden) für verschiedene Motorgrößen sind in der Tabelle 1.13. dargestellt. Die Werte basieren sich auf normale Bedingungen bei 50 Hz mit serienmäßigen Lagern und der Lebensdauer von 25000 Stunden. Auf 60 Hz sind die Werte um 50% reduziert. Für mehrtourige Motoren beziehen sich die Werte auf die höhere Geschwindigkeit. Zulässige Axialbelastungen (FA) auf das freie Wellenende (in N) für serienmäßige Lagerbestückung abhängig von der Einbaulage und Belastungsrichtung sind in den Tabellen 1.13. dargestellt.

Zulässige Radialbelastung (FR) auf das freie Wellenende (in N) für serienmäßige Lagerbestückung und Angriffspunkt $X = E/2$ (mm) unabhängig der Motoreinbaulage, ist in der Tabelle 1.13. dargestellt.

Tablica 1.12. / Table 1.12. / Tabelle 1.12.

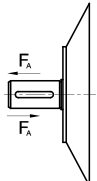
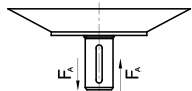
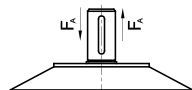
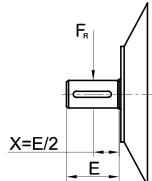
<p>AKSIJALNO OPTEREĆENJE AXIAL LOAD AXIALBELASTUNG</p>  <p>POLOŽAJ UGRADNJE IMB3, IMB5 MOUNTING ARRANGEMENT IMB3, IMB5 ANBAULAGE IMB3, IMB5</p>	<p>AKSIJALNO OPTEREĆENJE AXIAL LOAD AXIALBELASTUNG</p>  <p>POLOŽAJ UGRADNJE IMV5, IMV1 MOUNTING ARRANGEMENT IMV5, IMV1 ANBAULAGE IMV5, IMV1</p>	<p>AKSIJALNO OPTEREĆENJE AXIAL LOAD AXIALBELASTUNG</p>  <p>POLOŽAJ UGRADNJE IMV6, IMV3 MOUNTING ARRANGEMENT IMV6, IMV3 ANBAULAGE IMV6, IMV3</p>	<p>RADIJALNO OPTEREĆENJE RADIAL LOAD RADIALBELASTUNG</p>  <p>POLOŽAJ UGRADNJE IMB3, IMB5 MOUNTING ARRANGEMENT IMB3, IMB5 ANBAULAGE IMB3, IMB5</p>
--	--	---	--

F_A = aksijalna sila (N)

F_R = radijalna sila (N)

Dopušteno radijalno opterećenje F_R (N) na slobodni kraj vratila.

F_A = axial force (N)

F_R = radial force(N)

Permissible radial load F_R (N) on free shaft end.

F_A = Axialkraft (N)

F_R = Radialkraft(N)

Zulässige Radialbelastung F_R (N) auf das freie Wellenende.

$$F_R = \frac{19120 \cdot P \cdot c}{D \cdot n}$$

F_R = radijalna sila (N)

P = snaga motora (kW)

n = brzina motora (min-1)

D = promjer remenice (m)

c = koeficijent

- $c = 3$ (za ravni remen bez natezne remenice)
- $c = 2$ (za ravni remen sa nateznom remenicom)
- $c = 2,2 - 2,5$ (za klinasti remen)

F_R = radial force (N)

P = motor power (kW)

n = motor speed(rpm)

D = pulley diameter

c = coefficient

- $c = 3$ (flat belt without tension pulley)
- $c = 2$ (flat belt with tension pulley)
- $c = 2,2 - 2,5$ (for V belt)

F_R = Radialkraft (N)

P = Motornennleistung (kW)

n = Motordrehgeschwindigkeit (rpm)

D = Riemenscheibendurchmesser (m)

c = Koeffizient

- $c = 3$ (für Flachriemen ohne Spannriemenscheibe)
- $c = 2$ (für Flachriemen mit Spannriemenscheibe)
- $c = 2,2 - 2,5$ (für Keilriemen)

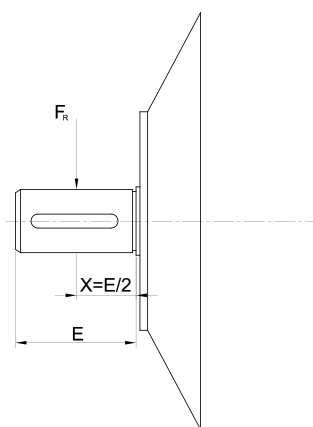

Važno:

Hvatište sile F_R ne smije biti izvan slobodnog kraja vratila ($X < E$). Vrijednosti F_R za druge položaje hvatišta unutar „E“ na upit.

Napomena:

Vrijednosti dopuštenih aksijalnih i radijalnih opterećenja vrijede za pogon kod 50Hz. Kod pogona sa 60Hz sve vrijednosti se umanjuju za 10%.

Vrijednosti za ostale uvjete opterećenja, a posebno kombinirana, na upit.

Important:

Vertex of the force F_R must not be out of the free shaft end ($X < E$). Values of F_R for different force inside „E“ upon request.

Note:

Values of permissible axial and radial loads are valid for duty cycle at 50Hz. All values are decreased by 10% for duty cycle at 60 Hz.

Values for other kind of loads, especially combined ones – upon request.

Wichtig:

Angriffspunkt der Kraft F_R darf nicht ausserhalb des freien Wellenendes liegen ($X < E$). Die Werte von F_R für die andere Angriffspunktlagen innerhalb von „E“ auf Anfrage.

Bemerkung:

Die Werte zulässiger Axial-u. Radialbelastungen gelten für den Betrieb bei 50Hz. Für den Betrieb bei 60Hz verringern sich alle Werte um 10%.

Die Werte für andere Belastungsbedingungen, besonders die kombinierten, auf Anfrage.

Tablica 1.13. / Table 1.13. / Tabelle 1.13.

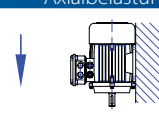
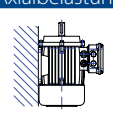
IEC	2p=	Aksijalno opterećenje <i>Axial load</i> Axialbelastung		Aksijalno opterećenje <i>Axial load</i> Axialbelastung		Aksijalno opterećenje <i>Axial load</i> Axialbelastung		Radijalno opterećenje <i>Radial load</i> Radialbelastung	
								X (mm)	F (N)
		IM B3; IM B5		IM V1; IM V5		IM V3; IM V6			
56	2	150	80	200	160	180	10	220	
	4	210	110	270	230	120		320	
	6	-	-	-	-	-		-	
	8	-	-	-	-	-		-	
63	2	220	150	300	240	210	11,5	280	
	4	270	170	340	270	230		340	
	6	330	220	410	360	270		400	
	8	390	300	450	480	320		410	
71	2	250	160	350	300	220	15	340	
	4	300	180	380	350	240		330	
	6	360	220	490	430	280		490	
	8	410	260	550	520	330		520	
80	2	400	260	560	590	280	20	470	
	4	470	300	650	670	340		650	
	6	560	360	750	780	410		740	
	8	640	430	850	1000	490		810	
90	2	490	300	660	670	340	25	670	
	4	550	350	800	790	400		790	
	6	690	440	900	950	480		930	
	8	810	520	1050	1110	570		1020	
100	2	630	410	880	890	480	30	940	
	4	730	460	1030	1040	550		1100	
	6	890	580	1290	1260	660		1320	
	8	1110	710	1420	1450	800		1460	
112	2	740	480	960	940	560	30	1000	
	4	860	560	1120	1050	630		1150	
	6	1090	720	1380	1290	760		1320	
	8	1230	820	1530	1500	870		1460	
132	2	1130	700	1520	1490	980	40	1200	
	4	1370	900	1820	1670	1140		1400	
	6	1680	1130	2110	2000	1380		1570	
	8	1880	1320	2370	2310	1550		1750	
160	2	1700	1400	1890	1750	1750	55	2130	
	4	1850	1730	2210	2030	2090		2400	
	6	2240	2100	2580	2350	2580		2780	
	8	2520	2430	2890	2690	2870		3020	
180	2	1900	1400	2600	2030	2100	55	2490	
	4	2220	1470	2880	2360	2270		2850	
	6	2470	1960	3360	2680	3030		3180	
	8	3060	2830	3760	3050	2320		3550	
200	2	2500	2000	3800	2650	3000	55	3300	
	4	2700	2100	3900	2750	3100		3500	
	6	3050	2520	4450	3330	3700		3800	
	8	3450	2850	5050	3600	4200		4500	
225	2	2650	3200	3250	2000	4600	70	3400	
	4	2750	3300	3350	2100	4700		3600	
	6	3150	3700	4500	2300	5600		4000	
	8	3650	4100	4600	2800	6000		4700	
250	2	2900	3500	3600	1800	3200	70	4400	
	4	4200	3600	5450	2400	4200		5000	
	6	4800	3700	6000	3500	5000		5700	
	8	5600	3800	6200	4200	5500		6300	
280	2	3430	2000	3610	1950	3240	70	4900	
	4	4320	2250	4690	2470	4220		5750	
	6	4550	3280	5680	3600	5110		6900	
	8	6270	3870	6300	4250	2670		7700	
315	2	4105	2100	4480	2050	4500	85	5850	
	4	5470	2870	5430	2800	5490		7200	
	6	5920	2970	6550	3025	6560		8400	
	8	6900	4070	7480	4130	7540		9600	

1.2.11. Priključna kutija

Gledajući u pogonsku stranu motora oblika IMB3 (s nogama) položaj priključne kutije izveden je prema Tablici 0.15:

U osnovnoj izvedbi motora u priključnoj kutiji smještena je priključna pločica sa šest priključnih stezaljki. Uz sve motore isporučuju se upute za priključak motora na izvor napajanja, a postaju dostupne kada se skine poklopac priključne kutije.

Višenaponski motori i motori s više brzina mogu imati i dvije priključne pločice koje se mogu smjestiti unutar priključne kutije. Takvi motori izrađuju se na poseban upit.

Jednofazni motori veličine IEC 63 – 100, u osnovnoj izvedbi izrađuju se s priključnom kutijom od plastične mase u kojoj se pored priključne pločice nalaze i pogonski kondenzatori. Takva priključna kutija se po potrebi može zakretati za 180° u odnosu na svoju podlogu kućišta.

Svaka priključna kutija opremljena je kabelskim uvodnicama i čepovima kojima se omogućava priključak motora na izvor napajanja. Broj uvodnica i čepova u osnovnoj izvedbi motora je prema Tablici 1.14.

1.2.11. Terminal box

Viewed from motor drive end of IMB3 mounting arrangement (with feet), position of terminal box is defined according to Table 0.15.

In motor basic design, terminal plate with six connection terminals is located in the terminal box. Each motor is supplied with instructions for connection to the power supply, which become accessible after terminal box cover dismounting.

Multi-voltage and multi speed motors can have two terminal plates, both situated inside the same terminal box. Such motors are produced on request. Single phase motors frame sizes IEC 63 – 100, in basic design, are produced with plastic terminal box where run and start capacitors are located besides terminal plate.

Each terminal box is equipped with cable glands and cable plugs through which motor connection on power supply is made possible. Number of glands and plugs in basic design is given in Table 1.14.

1.2.11. Klemmenkasten

Betrachtet von der Motorantriebsseite der Bauform IMB3 (mit Füßen) ist die Lage des Klemmenkastens nach der Tabelle 0.15. ausgeführt.

Bei der Motorgrundauführung befindet sich in dem Klemmenkasten das Klemmenbrett mit sechs Anschlussklemmen. Mit allen Motoren werden die Motoranschlussanweisungen auf der Speisequelle geliefert, welche zugänglich werden wenn man den Klemmenkastendeckel abnimmt. Mehrbereichsspannungs- u. mehrtourige Motoren können auch zwei Klemmenbretter haben, welche sich innerhalb des Klemmenkastens befinden können. Solche Motoren werden auf Sonderanfrage gefertigt.

Einphasige Motoren der Baugrößen IEC 63 – 100 sind in der Grundauführung mit dem Kunststoffklemmenkasten gefertigt in welchem sich neben dem Klemmenbrett auch die Betriebskondensatoren befinden. Solcher Klemmenkasten kann bei Bedarf um 180° zur seiner Gehäuseansatzfläche gedreht werden.

Jeder Klemmenkasten ist mit einer Kabelverschraubung und Stopfen versehen, mittels welcher der Motoranschluss auf der Speisequelle ermöglicht ist. Zahl der Kabelverschraubungen und Stopfen in der Motorgrundauführung ist in der Tabelle 1.14. gegeben.

Slika 1.6. / Picture 1.6. / Bild 1.6.

Standardna izvedba

Basic design

Grundauführung

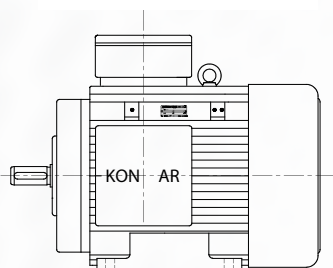

Gore /Up / Oben

Lijevo / left / Links

Desno / Right / Rechts

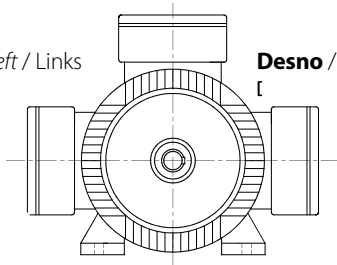

Ormarić bliže stražnjoj strani

Terminal box closer to NDE

Klemmkasten zur Lüfterseite

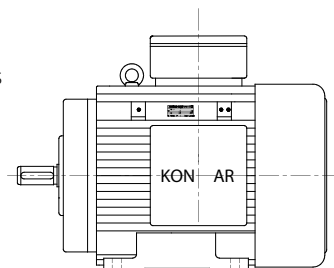

Tablica 1.14. / Table 1.14. / Tabelle 1.14.

IEC size	Osnovna izvedba Basic design Grundauführung			Opcije Options Optionen		
	Položaj kutije Terminal box position Klemmen- kastenlage	Mjesto uvoda Position of cable entry Einführungposition	Položaj uvoda Placement of cable entry Einführungposition	Položaj kutije Terminal box position Klemmenkastenlage	Mjesto uvoda Position of cable entry Einführungposition	Položaj uvoda Placement of cable entry Einführungposition
5AZ 56 – 90	gore <i>up</i> oben	kućište <i>Motor housing</i> Gehäuse	desno <i>right</i> rechts	desno, lijevo <i>right, left</i> rechts, links	poklopac <i>Terminal box lid</i> Klemmenkastendeckel kućište <i>Motor housing</i> Gehäuse	4 x 90° lijevo <i>left</i> links
5AZ 100 – 112	gore <i>up</i> oben	poklopac <i>Terminal box lid</i> Klemmenkastendeckel	desno <i>right</i> rechts	desno, lijevo <i>right, left</i> rechts, links	poklopac <i>Terminal box lid</i> Klemmenkastendeckel	4 x 90°
5AZ 132 – 160	gore <i>up</i> oben	kućište <i>Motor housing</i> Gehäuse	desno <i>right</i> rechts	desno, lijevo <i>right, left</i> rechts, links	poklopac <i>Terminal box lid</i> Klemmenkastendeckel kućište <i>Motor housing</i> Gehäuse	4 x 90° lijevo <i>left</i> links
7AZ 112 – 315	gore <i>up</i> oben	ormarić <i>Terminal box</i> Klemmenkasten	desno <i>right</i> rechts	desno, lijevo <i>right, left</i> rechts, links	ormarić <i>Terminal box</i> Klemmenkasten	4 x 90°

1.2.12. Uvod kabela u osnovnoj izvedbi

Uvod kabela može biti izveden na više načina ovisno od položaja priključne kutije, odnosno oblika ugradnje. Na plastične priključne kutije koriste samo plastične uvodnice.

1.2.12. Cable entry in basic motor design

Cable entry can be executed in several ways, depending on the position of terminal box or mounting arrangements. Use only plastic cable glands on plastic terminal boxes.

1.2.12. Kabeleinführung in der Grundauführung

Die Kabeleinführung kann auf mehrere Weisen abhängig von der Klemmenkastenlage oder Einbauformen ausgeführt sein. Auf dem Kunststoffklemmenkasten soll man nur die Kunststoffkabelverschraubungen einsetzen.

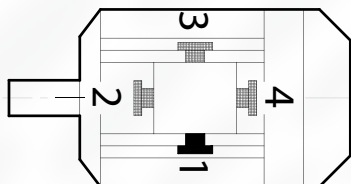

Slika 1.7. / Picture 1.7. / Bild 1.7.

Tablica 1.15. / Table 1.15. / Tabelle 1.15.

IEC	Standard		H klasa		Kabel s opletom armored cable armierte Kabel	
	5 AZ / 7 AZ		ostalo na zahtjev other upon request andere auf Anfrage		na zahtjev upon request auf Anfrage	
	Broj i Veličina uvodnice Number and size of cableglands Zahl und Größe der Kabelverschraubung	Promjer priključnog kabela Outer cable diameter Kabelmantel- durchmesser	Broj i Veličina uvodnice Number and size of cableglands Zahl und Größe der Kabelverschraubung	Promjer priključnog kabela Outer cable diameter Kabelmantel- durchmesser	Broj i Veličina uvodnice Number and size of cableglands Zahl und Größe der Kabelverschraubung	Promjer priključnog kabela Outer cable diameter Kabelmantel- durchmesser
	Plastic		Metal		Metal	
*						
**						
***	1x M16x1,5	5-10 mm	1x M16x1,5	4-9 mm	1x M16x1,5	3-12 mm
56						
63						
71						
80					1x M20x1,5	3-12 mm
90	1x M20x1,5	10-14 mm	1x M20x1,5	10-14 mm		
100					1x M25x1,5	10-18 mm
112						
132	1x M32x1,5+ plug M32x1,5	13-19 mm	1x M32x1,5+ plug M32x1,5	16-24 mm	1x M32x1,5+ plug M32x1,5	14-24 mm
160						
180	1x M40x1,5+ plug M40x1,5	19-28 mm	1x M40x1,5+ plug M40x1,5	22-32 mm	1x M40x1,5+ plug M40x1,5	22-32 mm
200	2x M40x1,5	19-28 mm	2x M40x1,5	22-32 mm	2x M40x1,5	22-32 mm
225	2x M50x1,5	29-38 mm	2x M50x1,5	29-38 mm	2x M50x1,5	26-35 mm
250	2x M50x1,5	29-38 mm	2x M50x1,5	29-38 mm	2x M50x1,5	26-35 mm
280	2x M50x1,5	29-38 mm	2x M50x1,5	29-38 mm	2x M50x1,5	26-35 mm
315	-	-	2x M63x1,5	35-41 mm	2x M63x1,5	35-45 mm

* **Grijači** / heaters / Heizkörper

** PTC

*** **Kočnice** / Brakes / Bremsen

Na poseban zahtjev motori mogu biti opremljeni i drugim brojem i veličinama uvodnica.

Motori opremljeni s termosondom ili grijačem isporučuju se s dodatnom uvodnicom 1 x M16 za serije 5AZ/7AZ.

Motors can be equipped with different number of glands or different gland sizes upon request.

Motors equipped with thermal probe or heater are delivered with additional cable gland 1xM16, for series 5AZ/7AZ.

Auf Anfrage können die Motoren mit anderen Kabelverschraubungszahlen u. -Größen bestückt sein. Die Motoren bestückt mit der Thermosonde oder Stillstandsheizkörper liefert man mit der Kabelverschraubung 1xM16 für die Baureihen 5AZ/7AZ aus.

1.2.13. Vrste hlađenja

Način označavanja metode hlađenja vezan je uz standard IEC 60034-6. Najčešći načini hlađenja su pokazani u tablici 1.16.

1.2.13. Type of cooling

Designation system concerning methods of cooling refers to standard IEC 60034-6. The most common cooling types are shown in the Table 1.16.

1.2.13. Kühlungsarten

Die Bezeichnungsart der Kühlungsarten ist mit der Norm IEC 60034-6 verbunden. Die meist verwendeten Kühlungsarten sind in der Tabelle 1.16. dargestellt.

Tablica 1.16. / Table 1.16 / Tabelle 1.16.

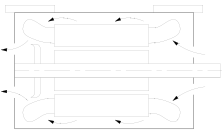
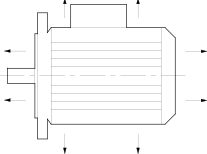
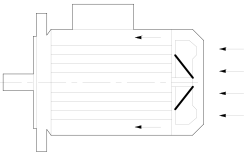
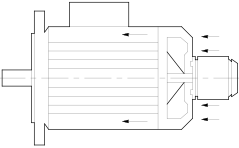
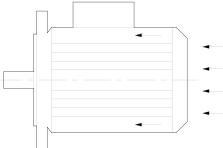
Code	Opis	Description	Beschreibung
IC 01 	Samostalno hlađenje otvorenih motora. Ventilator montiran na osovini motora.	<i>Independently cooled open motors. Fan mounted on motor shaft.</i>	Unabhängige Kühlung offener Motoren. Lüfterrad auf der Motorwelle montiert.
IC 410 	Hlađenje preko površine prirodnom konvekcijom i radijaciom. Zatvoren motor je bez vanjskog ventilatora.	<i>Cooling over surface through natural convection and radiation. Closed motor without external fan.</i>	Oberflächenkühlung durch freie Konvektion und Radiation. Geschlossener Motor ohne Aussenlüfter.
IC 411 	Hlađenje preko ravnih i orebrenih površina kućišta motora ventilatorom, montiranim na osovinu.	<i>Cooling over flat and ribbed surfaces with fan mounted on motor shaft.</i>	Kühlung über gerade und gerippte Gehäuseoberflächen mit einem auf der Motorwelle montierten Lüfterrad.
IC 416 	Hlađenje stranom ventilacijom sa svojim pogonom.	<i>Forced ventilated motor, with independently driven fan.</i>	Kühlung durch Fremdbelüftung mit Eigenantrieb.
IC 418 	Hlađenje zatvorenih motora u struji zraka nastalog radom pogonskog sustava motora (npr. pogona ventilatora).	<i>Air stream cooled closed motors. Cooling air stream as result of operation of motor drive system (e.g. fan drive).</i>	Kühlung geschlossener Motoren in dem Luftstrom entstanden durch die Arbeit des Motors. (z.B. Aussenlüfterantrieb). Der Motor ist ohne Lüfterhaube und Lüfterrad.

Motore su potpuno zatvoreni, a hlađenje se ostvaruje odvodom topline preko orebrenog kućišta pomoću ventilatora montiranog s vanjske strane motora na vratilo i zaštićenog ventilatorskom kapom (IC 411 prema IEC 60034-6). Ventilator je takvog oblika da se motor može nazivno opteretiti bez obzira na smjer vrtnje.

Motore treba montirati uvijek tako da rashladni zrak može oko njih nesmetano strujati. Ulazni otvori zraka na ventilatorskoj kapi moraju biti slobodni, a razmak od ventilatorske kape do prepreke, koja može spriječiti ulaz zraka, smije biti najmanje polovina osne visine motora izražena u mm.

Motore se ne smiju postaviti pokraj toplih

Motors are completely closed, and cooling is generated through heat transfer over the ribbed housing with fan mounted on motor shaft outside of the motor side and protected with a fan cap (IC 411 in acc. with IEC 60034-6). Fan is designed in such manner that it enables motor to be loaded with rated parameters regardless of direction of rotation.

Motors must be mounted to enable cooling air to stream around without any obstacle. Incoming air openings on fan cap must be opened and distance between fan cap and obstacle which can block air entering must be at least half of motor frame size rendered in mm.

Motors must not be positioned near warm objects,

Die Motoren sind völlig geschlossen und Kühlung erfolgt durch die Wärmeabführung über das gerippte Gehäuse mittels eines außerhalb des Motors auf der Welle montierten und mit der Lüfterhaube geschützten Lüfterrades (IC 411 nach IEC 60034-6). Die Form des Lüfters ermöglicht die Nennbelastung des Motors unabhängig von der Drehrichtung.

Die Motoren sollen immer so aufgestellt werden, dass die Kühlluft um diese frei strömen kann. Die Lufteintrittsöffnungen auf der Lüfterhaube müssen frei sein und der Abstand der Lüfterhaube von dem Hindernis, welcher den Lufttritt verhindern

tijela niti u zatvorene prostore s tako malom količinom zraka, da zagrijavanje motora utječe na porast temperature rashladnog zraka.

Ventilator i ventilatorska kapa ne smiju biti oštećeni niti skinuti dok motor radi, jer bez potpune ventilacije motor u trajnom radu ne može davati snagu naznačenu na natpisnoj pločici.

Za posebne vrste pogona motori mogu biti opremljeni ventilatorom s vlastitim pogonom (IC 416). Takve motore izrađujemo na poseban zahtjev.

Trofazni motori mogu raditi i u posebnim uvjetima kada je moguće odstraniti ventilator i ventilatorsku kapu:

- u slučaju kad stroj ima vanjsku ventilaciju tj. motor je u struji zraka neke vanjske ventilacije adekvatne ili bolje onoj od vlastite ventilacije (IC418). Motor u tom slučaju ima iste karakteristike kao motor s vlastitom ventilacijom.
- u slučaju kada motor radi u kratkotrajnom pogonu ili u intermitiranom pogonu bez ikakve ventilacije (IC 410), a zamašne mase radnog stroja ne utječu na dodatno zagrijavanje motora. Električne karakteristike će ostati nepromijenjene ukoliko se pridržavamo uvjeta iz Tablice 1.17.

neither in closed places with such quantities of air that heating of the motor could influence temperature rise of cooling air.

Fan and fan cap must not be damaged or dismantled during motor operation, because without full ventilation in continuous operation, motor cannot develop power stated on motor nameplate.

For special duty types, motor can be equipped with independently driven fan (IC 416). Such motors are produced on request.

Three-phase motors can be operated in specific conditions when it is possible to remove fan and fan cap:

- *in a situation when machine has external ventilation, i.e. motor is in air stream of some external ventilation adequate or better than own (IC418). In this case motor has same characteristics as motor cooled with own fan.*
- *in a situation when motor is operated in short duty cycle or in intermittent duty without any ventilation (IC 410), and fly wheel masses do not have any influence on additional motor heating. Electrical features will not be changed if conditions from Table 1.17. are fulfilled.*

könnte, muss mindestens die Hälfte der Motorachshöhe in mm betragen.

Die Motoren dürfen nicht neben warmen Körpern und in geschlossenen Räumen mit kleiner Luftmenge, so dass die Motorerwärmung den Temperaturanstieg des Kühlluftes beeinflusst, aufgestellt werden. Der Lüfterrad und die Lüfterhaube dürfen nicht beschädigt sein oder demontiert werden während der Motor läuft, weil ohne völlige Belüftung kann der Motor nicht die an dem Leistungsschild angegebene Leistung abgeben.

Für Sonderbetriebsarten können die Motoren mit eigenbetriebenem Lüfter (IC416) ausgerüstet sein. Solche Motoren fertigen wir auf Sonderanfrage.

Dreiphasige Motoren können auch unter Sonderbedingungen betrieben werden, falls der Lüfter und die Lüfterhaube entfernt werden können:

- wenn die Maschine eine Fremdbelüftung besitzt, d.h. der Motor befindet sich im Luftstrom einer Fremdbelüftung welche adequat oder besser vom Eigenbelüftung ist (IC418). Der Motor hat in diesem Fall die gleichen Charakteristiken wie der Motor mit der Eigenbelüftung.
- wenn der Motor sich im kurzzeitigen oder aussetzigen Betrieb ohne jegliche Belüftung (IC410) befindet, und die Schwungmassen der Arbeitsmaschine nicht auf die zusätzliche Motorerwärmung einwirken, werden die elektrischen Charakteristiken unverändert bleiben, insofern man sich an die Bedingungen aus der Tabelle 1.17. hält.

Tablica 1.17. / Table 1.17. / Tabelle 1.17.

Vrsta pogona / Duty cycle type / Betriebsart	Polaritet motora / Motor polarity / Motorpolarität			
	2	4	6	8
Kratkotrajni pogon S2 do <i>Intermittent duty cycle S2 up to</i> Kurzzeitbetrieb S2 bis	20'	30'	50'	50'
Intermitirani pogon S3/S6 do <i>Intermittent duty cycle S3/S6 up to</i> Aussetzbetrieb S3/S6 bis	25%	40%	60%	60%

U svim ostalim slučajevima pogona mijenjaju se električne karakteristike motora pa se takvi motori izrađuju na poseban zahtjev.

In all other duty cycle types motor electrical features are changing, therefore such motors are produced on request.

In allen anderen Betriebsfällen ändern sich die elektrischen Motorcharakteristiken, so dass man solche Motoren auf Sonderanfrage fertigt.

1.2.13.1. Prislilna ventilacija za trofazne asinkrone motore

Kod motora s vlastitom ventilacijom na malim brzinama vrtnje biti će smanjena dobava rashladnog zraka pomoću vlastitog ventilatora, a pri većim brzinama vrtnje motora biti će povećani mehanički gubici što dodatno opterećuje motor, a što će za rezultat dati lošije energetske pokazatelje sustava (npr. η - korisnost sustava se smanjuje, šumnost - buka se povećava i sl.).

Sklop strane ventilacije osigurava jednaku dobavu zraka za hlađenje u cijelom području brzine vrtnje motora budući da se motor ventilatora napaja iz nezavisne mreže konstantnog napona i frekvencije.

Tipizirani sklop strane ventilacije koji isporučuje KONČAR-MES sastoji se od jednofaznog ili trofaznog asinkronog motora i aksijalnog ventilatora, smještenog u ventilatorsku kapu za veličine motora osnih visina od 63 do 160, dok je za motore osnih visina od 180 do 315 predviđen sklop sa serijskim ventilatorima kataloških motora pogonjenih trofaznim asinkronim motorima KONČAR-MES. Namjena sklopa strane ventilacije je da osnovnom motoru osigura stalnu dobavu određene količine zraka za hlađenje, posebno u slučajevima kada vlastita ventilacija motora nije dostatna. Najčešći slučajevi su kada se motor pogoni preko regulatora brzine vrtnje u širokom opsegu regulacije i kada se od motora traže određene karakteristike opterećenja uvjetovane potrebama radnog mehanizma koji se pogoni. U tako zahtjevnim pogonima motoru treba osigurati odgovarajuće uvjete hlađenja u cijelom području rada.

1.2.13.1. Forced cooling for three-phase induction motors

Supply of cooling air over own fan shall be decreased at motors with own ventilation at low speeds and mechanical losses causing additional motor overloading at higher motor speed shall be increased, which additionally overloads motor and results in poor system energy indicators (e.g.) - system utilisation decreases, noise- noise level increases, etc.

Forced ventilation assembly assures equal supply of cooling air within complete speed regulation range, because fan motor is supplied independently from power source of constant voltage and frequency.

Unified assembly of forced ventilation produced by KONČAR-MES consists of a single or three-phase induction motor with axial fan, mounted on motor fan cap in sizes adequate to be fitted on IEC motor frame sizes 63 to 160, and for motor frame sizes 180 to 315 is provided assembly solution with serial produced motor fans mounted on shaft drive end of our catalogue three-phase induction motor. Application of forced cooling assembly is to ensure constant supply of certain quantity of cooling air to basic motor, especially when own ventilation is not sufficient. In most cases motor is driven by frequency inverter with wide regulation scope and when motor is expected to have certain load characteristics conditioned by driven working mechanism requirements. In such heavy drives, demanding drives, it is required provide adequate cooling conditions in the whole working range.

1.2.13.1. Fremdlüfter für dreiphasige Asynchronmotoren

Der meistvorkommende Fall ist, wenn man den Motor über den Frequenzrichter im breiten Regelbereich antreibt, und wenn man vom Motor bestimmte, durch die Bedürfnisse angetriebener Arbeitsmechanismen bedingte Belastungscharakteristiken, verlangt. In so aufwendigen Betrieben soll man dem Motor entsprechende Kühlungsbestimmungen im ganzen Arbeitsbereich sichern.

Bei Motoren mit eigener Belüftung wird bei kleinen Drehgeschwindigkeiten die Kühlluftzufuhr des Eigenlüfters verringert und bei höheren Motordrehgeschwindigkeiten werden mechanische Verluste vergrößert, was zusätzlich den Motor belastet und mit schlechteren energetischen Systemparametern resultieren wird (z.B. η – der Systemwirkungsgrad verringert sich, der Geräuschpegel erhöht sich, und ä.)

Typisierter Anbausatz der Fremdlüftung der von KONČAR-MES geliefert wird, besteht aus ein- oder drei-phasigem Asynchronmotor mit aufgezogenem Axiallüfterrad, der in der Lüfterhaube positioniert ist für die Motoren der Achshöhen von 63 bis 160, geeignet ist, während für die Motoren der Baugrößen von 180 bis 315 der Anbausatz mit Serienlüfterräder der Katalogmotoren, angetrieben mit dreiphasigen Asynchronmotoren von KONČAR-MES, geeignet ist. Die Aufgabe des Fremdlüftungsanbausatzes ist, dem Hauptmotor eine ständige Zufuhr bestimmter Kühlluftmenge zu sichern, besonders in den Fällen, wenn die Eigenlüftung nicht ausreichend ist.

Tablica 1.18. / Table 1.18. / Tabelle 1.18.

Standardna izvedba	Standard design	Standardausführung
Norme: IEC, VDE	Standards: IEC, VDE	Normen: IEC, VDE
Napon i frekvencija: 1(3)x230(400)V za veličine 63 – 160, 3x400 V za veličine 180 – 315, 50Hz	Voltage and frequency: 1(3)x230(400)V/50Hz for cooled motor frame sizes 63 to 160, 3x400V/50Hz for cooled motor frame sizes 180 to 315	Spannung und Frequenz: 1(3)x230(400)V/50Hz für fremdbelüftete Motorbaugrößen 63 bis 160, 3x400V/50Hz für fremdbelüftete Motorbaugrößen 180 bis 315
Stupanj zaštite: IP 55	Protection index: IP 55	Schutzgrad: IP 55
Priključni ormarić: na ventilatorskoj kapi (63 – 112), na motoru (132 – 315)	Terminal box: on fan cap of basic motor (63 – 112), on fan motor (132 – 315)	Klemmenkasten: auf der Lüfterhaube (63 – 112), auf dem Motor (132 – 315)
Vrsta pogona: S1	Duty type: S1	Betriebsart: S1
Izolacija: F (zagrijavanje u B)	Insulation: F (B rise)	Isolierung: F (Erwärmung im B)
Ton boje: RAL 5010	Colour tone: RAL 5010	Farbton: RAL 5010

Tehnički podaci

Technical data

Technische Daten

Tablica 1.19. / Table 1.19. / Tabelle 1.19.

Type	Q (m ³ /h)	U (V)	P1 (W)	I (A)
SV-63/1	54	230	59	0,21
SV-71/1	78	230	62	0,22
SV-80/1	127	230	67	0,23
SV-90/3	200	400	51	0,1
SV-100/3	260	400	51	0,1
SV-112/3	337	400	51	0,1
SV-132/3	450	400	81	0,21
SV-160/3	510	400	118	0,35
SV-180/3	580	400	200	0,6
SV-200/3	720	400	200	0,6
SV-225/3	1010	400	200	0,6
SV-250/3	1190	400	250	0,75
SV-280/3	1420	400	280	0,84
SV-315/3	1750	400	315	0,95

Opaska

u tipskoj oznaci sadržana je oznaka serije i IEC osna visina onog motora za koji je dotični sklop strane ventilacije prikladan, te oznaka broja faza u sklop ugrađenog pogonskog motora ventilatora. Npr. sklop SV-180/3 prikladan je za prigradnju na kataloške motore IEC osne visine 180, a u njega je ugrađen trofazni asinkroni motor pogona ventilatora.

Remark

type code contains series identification and IEC frame size of motor for which forced cooling assembly is adequate, and number of phases of fan mounted on drive motor unit. For example, assembly SV – 180/3 is appropriate to be mounted on standard catalogue motors of IEC frame size 180 and a three-phase induction motor is built in for fan drive.

Bemerkung

in der Typenbezeichnung sind die Baureihenbezeichnung und IEC Achshöhe des Motors, für welchen bestimmter Fremdlüftungssatz geeignet ist, enthalten. z.B. der Satz SV-180/3 ist geeignet für den Anbau auf Katalogmotoren der IEC Achshöhe / Baugröße 180 und in welchem der dreiphasige Asynchronmotor des Lüfterantriebs eingebaut ist.

Tablica 1.20. / Table 1.20. / Tabelle 1.20.

Mjerna skica / Dimensional drawing / Maßbild	
IEC 63 - 112	IEC 132 - 315

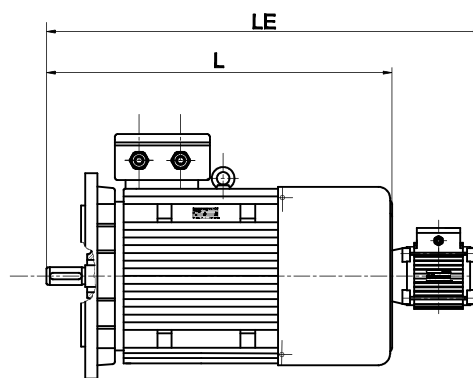
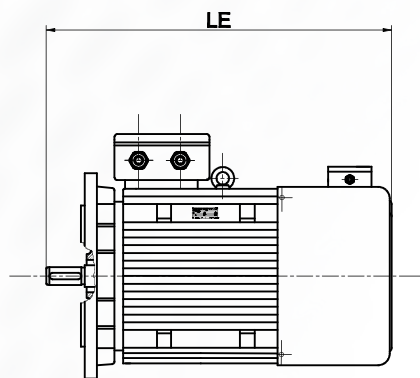

<p>Opaska: Dimenzije motora s prigradenim sklopom strane ventilacije i dodatno prigradenom elektromagnetskom kočnicom, prigradenim davačima broja okretaja i sl., daju se na poseban upit.</p>	<p><i>Remark: Motor dimensions with mounted forced ventilation kit and built-in fail safe electromagnetic brake, feedback device, etc., are given on request.</i></p>	<p>Bemerkung: Die Motorabmessungen mit angebaurem Fremdlüfter und zusätzlich angebaurem elektromagnetischer Bremse, angebaurem Drehzahlgeber und ä., werden auf Sonderanfragen gegeben.</p>
<p>Svi tehnički podaci su informativni te za njih proizvođač KONČAR-MES pridržava pravo promjene bez prethodne najave</p>	<p><i>All given technical data are informative and manufacturer KONČAR-MES reserves right to change without prior notice.</i></p>	<p>Alle technischen Daten sind informativ und der Hersteller KONČAR-MES behält das Änderungsrecht ohne Vorankündigung</p>

1.2.14. Vibracije

Stupanj kvalitete motora s obzirom na veličinu vibracija određen je propisom IEC 60034-14, iznosom efektivne brzine vibracija.

Stupanj kvalitete podijeljen je u dva razreda prema Tablici 1.24.

1.2.14. Vibrations

Quality level of motor, regarding level of vibration, is determined in directive IEC 60034-14 as figure of effective vibration speed.

Quality degree is divided in two levels according to the Table 1.24.

1.2.14. Vibrationen

Die Qualitätsstufe des Motors im Betracht auf die Vibrationsgröße ist mit der Vorschrift IEC 60034-14 durch den Effektivwert der Schwingstärke bestimmt.

Die Qualitätsstufe ist in zwei Klassen nach der Tabelle 1.24. verteilt.

Tablica 1.21. / Table 1.21. / Tabelle 1.21.

Granične vrijednosti za maksimalni stupanj vibracija (s) i brzina vibracija (v) za osnu visinu

Limits (rms values) for max. vibration quantity (s) and vibration speed (v) for the shaft height H

Grenzwerte für die maximale Vibrationsstufe (s) und Vibrationsgeschwindigkeit (v) für die Achshöhe H

Stupanj vibracija Vibration level Vibrationsstufe	Ugradnja stroja	Machine installation	Maschineneinbauart	Visina vratila u mm	Shaft Height H in mm	Achshöhe H in mm
				56 < H < 132	132 < H < 280	H > 280
				vrms mm/s	vrms mm/s	vrms mm/s
A	Slobodni ovjes	Free suspension	freie Aufhängung	1,6	2,2	2,8
	Čvrsti oslonac	Rigid clamping	feste Abstützung	1,3	1,8	2,3
B	Slobodni ovjes	Free suspension	freie Aufhängung	0,7	1,1	1,8
	Čvrsti oslonac	Rigid clamping	feste Abstützung	-	0,9	1,5

U standardnoj izvedbi naši rotori su dinamički uravnoteženi s polu-klinom (prema prema ISO 21940-32) i stupnjem vibracija razina A (normalni). Stupanj vibracija je valjan za nazivne frekvencije do 60Hz. Na zahtjev možemo isporučiti proizvod s reduciranim vibracijama u verziji B. Za motore pogonjene pretvaračem s frekvencijama preko 60Hz, standardna razina vibracija je B.

Balansiranje s punim klinom (dogovor pun klin) i balansiranje bez klina je dostupno na zahtjev.

In standard version our rotors are dynamically balanced with half key (acc. to ISO 21940-32) and vibration level A (normal). The vibration level A is valid for a rated frequency up to 60 Hz.

On request low-vibration version B can be supplied. For converter-fed operation with frequencies greater than 60 Hz standard quality level is low-vibration version B.

Balancing with full key (Agreement full-key) and Balancing without key are available on request.

In standardmäsiger Ausführung sind unsere Rotorwellen dynamisch mit halbem Keil (nach ISO 21940-32) und in der Vibrationsstufe A (normal) ausgewuchtet. Die Vibrationsstufe A bezieht sich auf die Nennfrequenzen bis 60 Hz. Auf Anfrage können wir die Vibrationsstufe B mit reduzierten Vibrationen ausführen. Für den FU-Betrieb auf höheren Frequenzen als 60 Hz ist die standarmäsige Vibrationsstufe B. Die Vollkeilauswuchtung (Vereinbarung: Vollkeil) und Auswuchtung ohne Keil ist auf Anfrage erhältlich.

1.3. Električna izvedba

1.3.1. Napon i frekvencija

Prema EN 60034-1 rasipanje standardnih napona i frekvencija mogu biti u kategoriji A (kombinacija odstupanja napona $\pm 5\%$ i odstupanja frekvencije $\pm 2\%$) i kategoriji B (kombinacija odstupanja napona $\pm 10\%$ i devijacije frekvencije $\pm 3-5\%$). Naši motori mogu dati nazivni moment u obje kategorije (A i B). U kategoriji A, zagrijavanje je oko 10K veće nego tijekom nazivnog pogona. Prema standardu, duži pogon nije preporučan za kategoriju B. Norma IEC 60038 standardi propisuju toleranciju $\pm 10\%$ za glavne napone 230V, 400V i 690V.

Trofazni kavezni asinkroni motori nazivnih snaga do 2,2kW izrađuju se standardno za napon 230/400V (spoj D/Y), a motori nazivnih snaga iznad 3kW za napon 400/690V (spoj D/Y). Nazivna frekvencija je 50Hz.

Elektromotori izrađeni za frekvenciju izvora napajanja 50Hz mogu se priključiti na izvor napajanja frekvencije 60Hz, pri čemu će brzina vrtnje motora porasti približno 20%. Izlazne karakteristike su date u tablici tehničkih podataka za 50Hz i 60Hz.

Ukoliko se uz povećanje frekvencije u istom omjeru povećao i napon izvora napajanja, motor se smije opteretiti s približno 15% većom snagom od snaga koje su navedene u tablici Tehnički podaci. Iznosi I_k/I_n , M_k/M_n i M_{max}/M_n ostaju približno isti.

Ukoliko je uz povećanje frekvencije napon izvora napajanja ostao isti, tada se snaga motora ne smije povećavati, a iznosi I_k/I_n , M_k/M_n i M_{max}/M_n smanjuju se na vrijednosti približno 85% od vrijednosti navedenih u tablici Tehničkih podataka.

Elektromotori namijenjeni za druge napone i frekvenciju izrađuju se na poseban upit.

1.3. Electrical features

1.3.1. Voltage and frequency

Acc. to EN 60034-1 standard voltages and frequency fluctuations can be in Category A (combination of voltage deviation $\pm 5\%$ and frequency deviation $\pm 2\%$) and Category B (combination of voltage deviation $\pm 10\%$ and frequency deviation $\pm 3-5\%$). Our motors can supply their rated torque in both Category A and Category B. In Category A, the temperature rise is approx. 10K higher than during rated duty. According to the standard, longer duty is not recommended for Category B. Standard IEC 60038 standard specifies a tolerance of $\pm 10\%$ for mains voltages of 230 V, 400 V and 690 V.

Three-phase squirrel cage induction motors with rated power up to 2,2 kW are made, as standard, for voltage 230/400V (connection D/Y), and motors with rated power 3 kW and above for voltage 400/690V (connection D/Y). Nominal frequency is 50Hz.

Electric motors produced for power source frequency of 50 Hz can be connected to the power source with frequency of 60 Hz, whereas motor revolving speed will be increased by approximately 20%. The outputs or rated characteristic are given in Technical Data tables for both 50 Hz and 60 Hz.

If voltage of power source is simultaneously increased with frequency increase in the same ratio, motor can be loaded with approximately 15% higher power than powers given in table Technical data. Values I_k/I_n , M_k/M_n and M_{max}/M_n remain the same.

If frequency is increased and voltage of power source remains the same, than motor power must not be increased and values I_k/I_n , M_k/M_n i M_{max}/M_n are reduced to 85% of values given in the table Technical data.

Electric motors intended to be used for other combinations of voltage and frequency – on request.

1.3. Elektrische Ausführung

1.3.1. Spannung und Frequenz

In Bezug auf EN 60034-1 kann die Verstreuung der standarmässigen Spannungen und Frequenzen in der Kategorie A (die Kombination der Spannungsabweichung $\pm 5\%$ und der Frequenzabweichung $\pm 2\%$) und in der Kategorie B (die Kombination der Spannungsabweichung $\pm 10\%$ und der Frequenzabweichung $\pm 3-5\%$) sein werden. Unsere Motoren können das Nennmoment in beiden Kategorien (A und B) abgeben. In der Kategorie A, ist die Erwärmung um etwa 10K höher als im Nennbetrieb. Nach der Norm ist ein längerer Betrieb nicht für die Kategorie B zu empfehlen. Die Norm IEC 60038 schreibt die Toleranz $\pm 10\%$ für Netzspannungen 230 V, 400 V und 690 V vor.

Dreiphasige Asynchronmotoren mit Käfigläufer der Nennleistungen bis 2,2kW sind serienmässig für die Spannung 230/400V (Schaltung D/Y) und die Motoren der Nennleistungen über 3kW für die Spannung 400/690V (Schaltung D/Y) gefertigt.

Die Nennfrequenz beträgt 50Hz.

Die Elektromotoren gefertigt für die Frequenz der Speisequelle von 50Hz kann man auf die Speisequelle der Frequenz von 60Hz anschließen wobei die Drehgeschwindigkeit des Motors um etwa 20% steigen wird.

Die Ausgangscharakteristiken sind in der Tabelle der technischen Daten für 50 Hz und 60 Hz gegeben.

Wenn sich bei der Frequenzerhöhung im gleichen Verhältnis auch die Spannungsquelle erhöht hat, kann man den Motor mit annähernd 15% höheren Leistung von den in der Tabelle technischer Daten gegebenen Werten belasten. Die Werte I_k/I_n , M_k/M_n und M_{max}/M_n bleiben dabei annähernd unverändert.

Wenn bei der Frequenzerhöhung die Spannung der Speisequelle gleichgeblieben ist, darf man die Motorleistung nicht erhöhen und die Werte I_k/I_n , M_k/M_n und M_{max}/M_n verringern sich annähernd auf 85% der Werte, die in der Tabelle technischer Daten gegeben sind.

Die Elektromotoren für andere Spannungen und Frequenz fertigt man auf Sonderanfrage.

1.3.2. Nominalna brzina i smjer vrtnje

Nominalne brzine su primjenjive za nazivne podatke. Sinkrona brzina se mijenja proporcionalno s frekvencijom. Motori su prikladni za smjer vrtnje u smjeru kazaljke na satu i obrnutom.

Ako su U1, V1 i W1 povezani s L1, L2 i L3, rezultat je rotacija u smjeru kazaljke na satu kada se gleda motor s prednje strane.

Rotacija u smjeru obrnutom od kazaljke sata se postiže zamjenom dvije faze.

1.3.3. Nominalni moment

Nazivni moment u Nm na izlaznom vratilu je:

P= nazivna snaga u kW
n= brzina u o/min

Moment kratkog spoja i maksimalni momenti su navedeni u tehničkim podacima kao umnožak s nominalnim momentom. Praksa je da se kavezni motori pokreću direktno.

1.3.4. Nazivna struja

Nazivna struja na nazivnom naponu i nazivnom opterećenju je prikazana u tablici s tehničkim podacima.

Električne značajke su date u tehničkim podacima i podliježu tolerancijama definiranim u direktivama IEC 60034.

1.3.5. Preopterećenje

Motori iz ovog kataloga mogu podnijeti kratkotrajno preopterećenje u trajanju od 2 minute s 1,5 puta većim nazivnim strujama nakon očitavanja radne temperature na nazivnom opterećenju.

1.3.2. Rated speed and direction of rotation

The rated speeds are applicable for the rated data. The synchronous speed changes proportionally with the line frequency. The motors are suitable for clockwise and counter-clockwise rotation.

If U1, V1, W1 are connected to L1, L2, L3, clockwise rotation results as viewed onto the drive-end shaft extension. Counterclockwise rotation is achieved by swapping two phases.

1.3.3. Rated torque

The rated torque in Nm delivered at the motor shaft is:

$$M = \frac{9550 \cdot P}{n}$$

P= rated output in kW
n= speed in rpm

The locked-rotor torque and breakdown torque are listed in the Technical Data tables as multiples of the rated torque.

The normal practice is to start squirrel-cage motors directly on line.

1.3.4. Rated current

Rated motor current at rated voltage and rated load is given in the Technical Data Table.

Electrical features given in Technical Data Table are subject to tolerances given in directives IEC 60034.

1.3.5. Overload capacities

Motors mentioned in this catalogue can withstand short-time overload during 2 minutes with 1,5 times bigger rated current after reading operating temperature at rated load.

1.3.2. Nenndrehzahl und Drehrichtung

Die Nenndrehzahlen sind für die Nenndaten verwendbar. Die Synchrondrehzahl ändert sich proportionell mit der Frequenz. Die Motoren sind geeignet für die Uhrzeigerdrehrichtung oder umgekehrt geeignet.

Wenn die U1, V1, W1 mit der L1, L2, L3 verbunden sind resultiert das im Uhrzeigerdrehrichtung wenn man den Motor von der Antriebsseite blickt. Die Rotation gegen der Uhrzeigerdrehrichtung erzielt man wenn die zwei Phasen untereinander gewechselt werden.

1.3.3. Nennmoment

Das Nennmoment in Nm auf der Antriebswelle beträgt:

P=Nennleistung in kW
n= Drehzahl in U/min

Das Anlaufmoment und Kippmoment sind in der Tabelle mit technischen Daten als Multiplizierungswert mit dem Nennmoment angegeben. Normalerweise startet man die Käfigläufermotoren direkt.

1.3.4. Nennstrom

Der Nennstrom bei der Nennspannung und Nennbelastung ist in der Tabelle mit technischen Daten angegeben. Die elektrischen Eigenschaften sind in der Tabelle mit technischen Daten angegeben und unterliegen der Toleranzen welchen in der Richtlinien IEC 60034 definiert sind.

1.3.5. Überlastung

Die Motoren aus diesem Katalog können eine kurzzeitige Überlastung im Dauer von zwei Minuten mit 1,5 Mal höheren Nennströmen, nach der Ablesung der Arbeitstemperatur auf der Nennbelastung ertragen.

1.3.6. Električna zaštita

Motori u pogonu trebaju biti zaštićeni od kratkog spoja, preopterećenja i pregrijavanja. Kao sredstva zaštite mogu poslužiti osigurači, sklopnici s bimetalnim okidačima i motorne zaštitne sklopke.

- Osigurači s tromim ili brzim okidanjem nedovoljna su zaštita motora. Oni štite motor samo od kratkog spoja, ali ne i od preopterećenja ili pregrijavanja. Rastavne uloške osigurača u dovodnom krugu motora treba odabrati prema struji pokretanja. Za izravno uklapanje motora čije vrijeme zaleta iznosi do 5 sekundi dovoljni su tromi ulošci osigurača čija struja odgovara $1.3 \times I_n$ motora. Za motore koji se uklapaju preklopkama zvijezda – trokut dovoljni su tromi ulošci čija struja odgovara nazivnoj struji motora.
- Sklopnici s bimetalnim okidačima štite motor od oštećenja koja nastaju uslijed preopterećenja. Kod motora koji rade u trajnom pogonu S1 bimetalni okidači podešavaju se na vrijednost nazivne struje motora. U tom slučaju oni štite motor od pregrijavanja koje nastaje zbog preopterećenja radnog stroja, smanjenjem ili povećanjem napona izvora napajanja ili gubitka jedne faze. Ovisno o duljini trajanja zaleta bimetalni okidači omogućuju nesmetani zalet motora. Za zaštitu od kratkog spoja potrebno je ispred sklopnika dodati trome osigurače.
- Motorna zaštitna sklopka je uređaj koji omogućuje ukapčanje i iskapčanje motora, a istovremeno zaštićuje motor. U sklopku su ugrađeni bimetalni okidači za zaštitu od preopterećenja i brzi elektromagnetski okidači za zaštitu od kratkog spoja. Takve sklopke se mogu opremiti i podnaponskim okidačem koji isključuje motor s napajanja ukoliko napon padne na 50% vrijednosti ili nestane napona napajanja. Podnaponski okidač ujedno isključuje i samu sklopku. Nakon što je nestao uzrok isklapanja sklopke, sklopku treba ponovo ukopčati ručno, pritiskom na tipkalo.

1.3.6. Electrical protection

Motor during operation must be protected from short circuit, overloads and overheating. The following may be used as protection instruments: fuses, contactors with bimetal triggers and motor protection circuit breaker.

- *Fuses with inert or fast triggering are not sufficient as motor protection. They protect motor only from short circuit but not from overload or overheating. Melting cartridges of fuses in supplying circuit should be selected according to starting current. For direct switching of motors with starting time up to 5 sec., fuses with inert cartridges are sufficient, where current is equal $1.3 \times I_n$ of motor. For motors which are switched through star-delta switches inert fuses using the same current as motor rated current.*
- *Contactors with bimetal triggers protect motor from damages due to overload. In continuously operating motors (S1 duty) bimetal triggers are calibrated to the value of motor rated current. In this case they protect motor from overheating occurring because of driving machine overload, reduced or increased power supply voltage or loss of one phase. Depending on starting time, bimetal trigger enabling unobstructed motor starts. For short circuit protection it is necessary to connect inert fuses in the front of contactor.*
- *Motor protection circuit breaker is device which enables motor switching on and off and at the same time protects motor. Bimetal triggers are installed in circuit breakers as overload protection and fast electromagnetic triggers as short circuit protection. Such circuit breakers can be equipped with undervoltage trigger for power supply disconnection if voltage drops to 50% of value or because of total lack of power supply. Undervoltage trigger switches off the switch itself at the same time. After the cause of switching off has been removed, the switch must be switched on manually by pressing the button.*

1.3.6. Elektrischer Schutz

Die Motoren sollen im Betrieb gegen den Kurzschluss, Überlastung und Überhitzung geschützt sein. Als Schutzmittel dienen Sicherungen, Schützen mit Bimetallauslöser und Motorschutzschalter.

- Schmelzsicherungen mit trägen oder schnellen Auslösern sind für den Motorschutz nicht ausreichend. Sie schützen den Motor nur gegen Kurzschluss aber nicht gegen Überlastung oder Überhitzung. Die Schmelzeinsätze der Sicherungen in dem Zuleitungskreis des Motors soll man nach dem Anlaufstrom auswählen. Für direktes Einschalten des Motors, dessen Anlaufzeit bis zu 5 Sekunden beträgt, genügen die träge Schmelzeinsätze der Sicherungen, deren Strom $1.3 \times I_n$ des Motors entspricht. Für die Motoren, die mit dem Stern-Dreieck Umschalter eingeschaltet werden, genügen die träge Schmelzeinsätze, deren Strom dem Nennstrom des Motors entspricht.
- Schalter mit Bimetallauslösern schützen den Motor vor Beschädigungen die infolge einer Überlastung entstehen können. Bei Motoren im Daürbetrieb S1 werden die Auslöser auf den Nennstrom des Motors eingestellt. Dann schützen sie den Motor gegen Überhitzung, die durch Überbelastung der Arbeitsmaschine, Nennspannungsabfall, bzw. Erhöhung oder Unterbrechung in einer Phase der Zuleitung entstehen kann. Abhängig vom Anlaufdauer ermöglichen die Schalter mit Bimetallauslösern einen einwandfreien Anlauf des Motors. Als Schutz vor dem Kurzschluss muss man in die Zuleitungen vor den Schaltern träge Sicherungen einsetzen.
- Motorschutzschalter ist eine Einrichtung, die dazu dient, den Motor ein- und ausschalten und ihn gleichzeitig zu schützen. In dem Schalter sind Bimetallrelais für den Schutz gegen Überlastung und elektromagnetische Schnellauslöser zum Schutz gegen Kurzschluss eingebaut. Die Motorschutzschalter können auch mit einem Unterspannungsauslöser ausgerüstet werden, welcher im Falle des Netzspannungsabfalls auf 50% des Nennspannungswertes oder völligen Spannungsausfalls den Motor vom Netz abtrennt. Der Unterspannungsauslöser schaltet gleichzeitig auch den Motorschutzschalter aus. Nach dem Verschwinden der Ursache für das Ausschalten des Schalters, muss man ihn wieder per Handdruck auf den Taster einschalten.

1.3.7. Termička zaštita

Za razliku od električne zaštite koja se postavlja izvan motora, termička zaštita se ugrađuje u namot motora i izravno reagira na povišenje temperature od koje ovisi vijek trajanja izolacijskog sustava. Ovom zaštitom motore je moguće štiti od pregrijavanja uslijed teških zaleta, velikog broja uklapanja i sl.

Termička zaštita ugrađuje se na poseban zahtjev, a izvodi se na slijedeći način:

- 3 termosonde PTC T150 spojene u seriju – izvodi u priključnom ormariću spojeni na redne stezaljke. Za ovakav način zaštite potrebno je na izvode termosondi spojiti termorelej koji će sa svojim kontaktima upravljati krugom sklopnika.
- 3 termoprotektora T150 bimetalni prekidači otvarajući spojeni u seriju – izvodi u priključnom ormariću spojeni na redne stezaljke. Za ovakav način zaštite dovoljno je u krug držanja sklopnika spojiti termoprotektore koji će u slučaju pregrijavanja motora otvoriti kontakte, isključiti krug držanja sklopnika i time isključiti motor s napajanja. Kada se motor ohladi kontakti prekidača će se zatvoriti, a motor treba ručno pokrenuti pritiskom na tipkalo sklopnika.
- Kod jednofaznih motora zaštita se izvodi na isti način, samo se umjesto 3 termosonde ili 3 termoprotektora stavljaju po dvije termosonde ili dva termoprotektora, u svaku fazu po jedan element.

Na poseban zahtjev elektromotori mogu biti opremljeni i drugim vrstama i karakteristikama termičkih zaštita (PTC T120, T130, PT100,...). Kada je motor opremljen s termičkom zaštitom, priključna kutija izvedena je s dodatnom uvodnicom M16.

1.3.7. Thermal protection

Unlike the electrical protection which is placed outside the motor, thermal protection is inserted into motor winding and directly reacts to the rise in temperature, which life time of insulation system is directly dependant on. That way it is possible to protect motors from overheating during heavy duty starts and many starting cycles in short period of time, etc...

Thermal protection is built in on request, and it is executed as follows:

- *3 thermal probes PTC T150 serial connected – leads connected to the fasteners in terminal box. It is necessary to connect thermal relays on the probe leads for controlling of contactor circuit through relay contacts for such kind of protection.*
- *3 thermal switch T150 bimetal switches serial connected – leads connected to the fasteners in terminal box. For this kind of protection it is enough to connect thermal switches to contactor holding circuit, which will in case of motor overheating open contacts, cut off contactor holding circuit and at same time cut off motor from the supplying net. When motor is cooled down, switch contacts will be closed and motor must be manually restarted by pressing contactor push buton.*
- *In single-phase motors protection is executed in the same manner, except instead of 3 thermal probes or 3 thermal swithches only two probes or thermal switches are built in. In each phase there is one element.*

On request electric motors can be equiped with thermal protection of different types and characteristics (PTC 120, T 130, PT100 ...) When motor is equiped whit thermal protection of any kind, additional cable gland M16 is mounted on the terminal box.

1.3.7. Thermischer Schutz

Im Unterschied zum elektrischen Schutz, der ausserhalb des Motors aufgestellt wird, reagiert der thermische Schutz, der in der Wicklung des Motors eingebaut wird, direkt auf eine Erhöhung der Wicklungstemperatur, von welcher meistens die Lebensdauer des Isolationssystems abhängig ist. Mit diesem Schutz kann man die Motoren gegen Überhitzen verursacht durch schwere Anläufe, große Einschalthäufigkeit u.ä. schützen. Thermischer Schutz wird auf Sonderanfrage eingebaut und ist auf folgende Weise ausgeführt:

- 3 PTC T150 Kaltleiter in Serie geschaltet – Ausführungen im Klemmenkasten auf Lusterklemmen verbunden. Bei dieser Schutzart ist es notwendig, an die Kaltleiterausführungen das Thermorelais anschliessen, das über seine Kontakte den Schalterkreis steuern wird.
- 3 Thermoschalter T150, öffnender Bimetallauslöser in Serie geschaltet – Ausführungen im Klemmenkasten auf Reihenklammen verbunden. Bei dieser Schutzart genügt es im Haltekreis der Schalter die Thermoschalter anzuschliessen, welche im Falle einer Überhitzung des Motors die Kontakte öffnet, den Haltekreis des Schützes ausschaltet und damit den Motor vom Netz abtrennt. Nach Abkühlung des Motors werden sich die Kontakte des Thermoschalters schliessen und der Motor soll per Handdruck auf den Schützentaster wieder angelassen werden.
- Bei einphasigen Motoren führt man den Schutz auf gleiche Weise aus, jedoch benutzt man anstelle von 3PTC Kaltleiter oder 3 Thermoschalter die 2 PTC Kaltleiter oder 2 Thermoschalter, wobei in jeder Phase ein Schutzelement eingebaut wird.

Auf Sonderanfrage können die Elektromotoren auch mit anderen Arten und Eigenschaften thermischen Schützes PTC T120, T130, PT100,...) ausgerüstet sein. Wenn der Motor mit thermischem Schutz ausgerüstet ist, ist der Klemmenkasten mit zusätzlicher Kabelverschraubung M16 ausgeführt.

1.3.8. Način pokretanja

Trofazni kavezni asinkroni elektromotori nazivnih snaga do 2,2 kW najčešće se pokreću izravnim uklapanjem na napajanje budući da im je osnovni spoj zvijezda Y. Izravno uklapanje izvodi se najčešće pomoću odgovarajućih sklopki ili pomoću sklopnika.

Motori većih nazivnih snaga mogu se također uklapati izravno, međutim, pritom se javljaju velike struje uklapanja, čiji iznosi su dani u tablicama Tehnički podaci, kao odnos struje uklapanja i nazivne struje elektromotora (I_k/I_n). Stoga treba provjeriti da li izvor napajanja podnosi tako velike udarce struja pri čemu treba uzeti u obzir i odredbe poduzeća za distribuciju električne energije.

Kod motora s nazivnom snagom iznad 3 kW namot se izvodi tako da omogućava uklapanje motora na principu zvijezda – trokut.

Motor se u zaletu preklopi u spoj zvijezda, a nakon završenog zaleta preklopi u spoj trokut. Pri ovakvom načinu uklapanja potezni momenti i struje uklapanja smanjuju se na cca jednu trećinu od iznosa navedenih u tablici Tehnički podaci.

Pokretanje zvijezda - trokut postiže svoju svrhu samo kada se motor u spoju zvijezda zavrti do brzine blizu nazivne brzine vrtnje.

To je moguće samo kod zaleta malih zamašnih masa ili s malim protumomentom tereta npr.: alatni strojevi, centrifugalne crpke, kompresori sa zatvorenim zasunom i sl.

Potezni momenti navedeni u tablicama odnose se na izravna uklapanja elektromotora na izvor napajanja.

Jednofazni motori u svrhu zaštite kondenzatora, ne preporučuju se startati više od dvadeset puta u jednom satu. Trofazne kavezne asinkrone elektromotore dopušteno je startati do 3 puta u jednom satu u "toplom" stanju (motor zagrijan na radnu temperaturu).

1.3.8. Starting mode

Three phase squirrel cage induction motors with rated powers up to 2.2 kW are mostly started over direct switching on supply where as they are basically connected in star Y. Direct switching is performed through adequate circuit breakers or contactors.

Motors with higher rated powers can be started directly, nevertheless, high starting (locked rotor) currents are occurring, figures given in the table Technical data as ratio between starting current and motor rated current (I_k/I_n). Therefore it is necessary to check if power source can sustain such high current shocks and at the same time regulations of company for electrical power distribution must be taken into consideration.

In motors with rated power 3 kW and above, winding is performed in such way to enable motor starting on principle star - delta.

During starting, motor is switched in star connection and when starting is finished it is switched to delta connection. At this kind of switching, starting torques and switching currents are reduced to approximately one third of figures given in the table Technical data.

Starting star-delta reaches its purpose only when star connected motor reaches speed nearly to nominal revolving speed. This is possible only with runs of small fly wheel masses or with small load counter torque e.g.: tooling machines, centrifugal pumps, compressors with closed valve etc.

Starting torques given in the table are related to direct switching of motor on power source.

Single-phase motors for the purpose of capacitor protection are not to be started more than twenty times during one hour period. Three-phase induction motors are allowed to be started 3 times during one hour period in "warm" condition (motor heated to the operating temperature).

1.3.8. Anlaufarten

Dreiphasen Asynchronmotoren mit Käfigläufer der Nennleistungen bis 2.2kW werden meistens mit direktem Einschalten an Speisernetz angelaufen, weil ihre Grundverbindung der Stern Y ist. Direktes Einschalten führt man meistens mit der Hilfe des entsprechenden Schalters oder Schützes aus.

Die Motoren grösserer Leistungen können auch direkt eingeschaltet werden, jedoch treten dabei große Einschaltströme auf (die Werte sind in der Tabellen technischer Daten angeführt als das Verhältnis zwischen dem Anlaufstrom und dem Nennstrom des Motors I_k/I_n). Deswegen soll man überprüfen ob die Speisequelle so große Stromstöße verträgt, wobei auch die Bestimmungen des Verbundnetzunternehmens beachtet werden sollten.

Bei Motoren mit einer Nennleistung über 3kW ist die Wicklung so ausgeführt, das Einschalten nach dem Prinzip Stern-Dreieck ermöglicht ist. Während des Anlaufs wird der Motor in den Stern und nach beendetem Anlauf zurück ins Dreieck umgeschaltet. Bei solchem Einschaltverfahren verringern sich die Anlaufmomente und Einschaltströme auf ungefähr einen Drittel der Werte, die in der Tabelle technischer Daten angeführt sind.

Das Stern-Dreieck-Anlaufverfahren hat seinen Zweck nur dann erreicht, wenn der im Stern geschaltete Motor die Drehgeschwindigkeit nahe der Nenndrehgeschwindigkeit erreicht.

Das ist nur beim Anlaufen von kleinen Schwungmassen oder mit geringem Gegenlastmoment möglich, wie z.B. Werkzeugmaschinen, Kreiselpumpen, Kompressoren mit geschlossenem Riegel u.ä.

In den Tabellen angeführten Anlaufmomente beziehen sich auf das direkte Einschalten des Motors ans Netz.

Einphasige Motoren ist es nicht empfehlenswert mehr als zwanzig mal pro Stunde zwecks Schutzes der Kondensatoren zu starten. Dreiphasige Motoren können bis zu 3 mal in einer Stunde im warmen Zustand gestartet werden (der Motor ist auf die Betriebstemperatur aufgewärmt).

1.3.9. Pogon preko frekventijskog pretvarača

Serije motora 5AZ i 7AZ su projektirane i ispitane u skladu s IEC 60034-1 i mogu raditi preko frekventijskog pretvarača u uvjetima u skladu s IEC 60034-25 u području regulacije od 5 do 100 Hz s opterećenjima prikazanim u grafikonu 1. 8. Motori predviđeni za pogon preko frekventijskog pretvarača u namotu imaju ugrađenu termičku zaštitu. Na dodatnoj natpisnoj pločici definirane su karakteristike motora pri radu na različitim frekvencijama.

1.3.9. Supply over frequency converter

Motors of 5AZ and 7AZ series are designed and tested in accordance with IEC 60034-1 and can be driven by frequency inverter in terms compatible with IEC 60034-25 within regulation range between 5 to 100 Hz loaded as shown in the Chart below. Motors designed for frequency inverter drive have a built-in thermal protection in winding. Motor characteristics in operation at various frequencies are defined on the additional nameplate.

1.3.9. Frequenzumrichterbetrieb

Die Motoren der Baureihen 5A7 und 7A7 sind projektiert und geprüft übereinstimmend mit IEC 60034-1 und können über den Frequenzumrichter angesteuert werden unter Bedingungen gemas 60034-25, im Regelbereich von 5 bis 100Hz unter den Belastungen, die in der Grafik 1.8. dargestellt sind. Motoren die für den Frequenzumrichterbetrieb vorgesehen sind haben in der Wicklung einen thermischen Schutz eingebaut. Auf zusätzlichem Leistungsschild sind die Motorcharakteristiken beim Betrieb auf verschiedenen Frequenzen definiert.

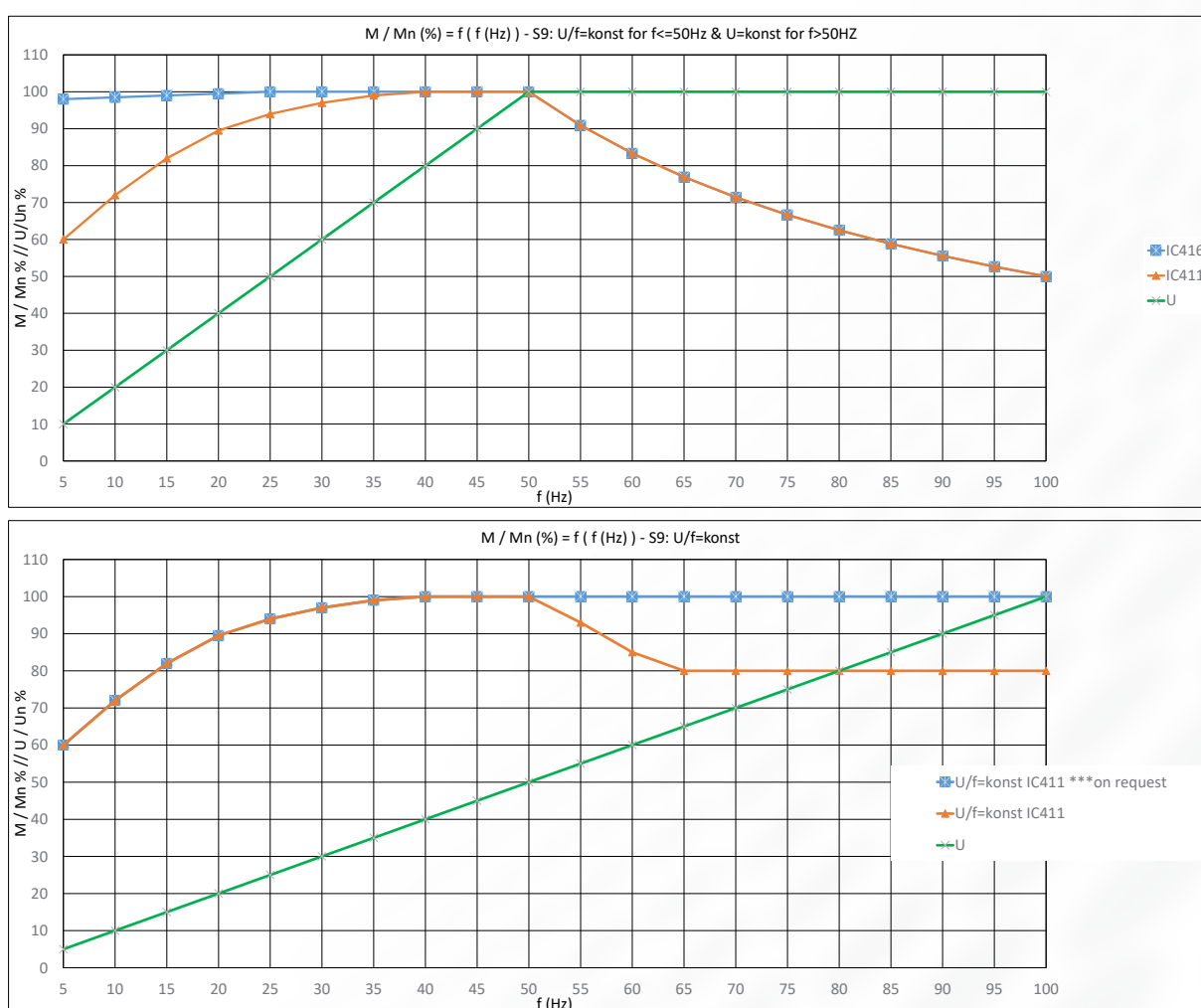

Slika 1.8. / Picture 1.8. / Bild 1.8.

Graf pogona preko pretvarača / Frequency inverter drive chart / Frequenzumrichterbetrieb

1.3.10. Grijači namota

Motori mogu biti opremljeni grijačima namota koji sprečavaju kondenziranje vlage unutar kućišta i namota motora tijekom mirovanja.

Grijači namota ugrađuju se u motor samo na poseban zahtjev. Izvodi grijača spajaju se na redne stezaljke unutar priključne kutije, a priključak za napajanje izvodi se prema priloženim uputama za priključak.

Standardno, ugrađuju se grijači prema Tablici 1.22.

1.3.10. Winding heaters

Motors can be equipped with winding heaters to prevent moisture condensation inside motor housing and winding during standstill.

Winding heaters are built in motors on request. Connections of heaters are connected on fasteners inside terminal box, and power supply connection is executed according to attached connection instructions.

Heaters according to the Table 1.22. may be built in as standard.

1.3.10. Wicklungsheizung

Die Motoren können mit einer Wicklungsheizung ausgerüstet sein, die die Feuchtigkeitskondensierung innerhalb des Gehäuses und der Motorwicklung während des Stillstands verhindert. Die Wicklungsheizung wird nur auf Sonderanfrage in die Motoren eingebaut. Die Leitungen der Heizkörper werden auf die Reihenklammern innerhalb des Klemmenkastens gekoppelt und der Netzanschluss wird nach beigelegten Anschlussanweisungen ausgeführt. Standardmäßig wird die Wicklungsheizung gemäß Tabelle 1.22. eingebaut.

Tablica 1.22. / Table 1.22. / Tabelle 1.22.

IEC	Grijač Heater Heizkörper
56/63	1 x 10 W / 230 V
71	1 x 25 W / 230 V
80	1 x 25 W / 230 V
90	1 x 25 W / 230 V
100	2 x 25 W / 230 V
112	2 x 40 W / 230 V
132	2 x 40 W / 230 V

IEC	Grijač Heater Heizkörper
160	2 x 40 W / 230 V
180	2 x 40 W / 230 V
200	2 x 40 W / 230 V
225	2 x 65 W / 230 V
250	2 x 65 W / 230 V
280	2 x 65 W / 230 V
315	2 x 65 W / 230 V

Kada je motor izveden s grijačima namota, priključna kutija opremljena je s dodatnom uvodnicom M16.

Tijekom rada motora, grijači moraju biti isključeni!

When motor is equipped with winding heaters, terminal box is equipped with additional cable gland M16.

Heaters must be turned off during motor operation.

Wenn der Motor mit einer Wicklungsheizung ausgerüstet ist, ist der Klemmenkasten mit zusätzlicher Kabelverschraubung M16 ausgeführt.

Während des Motorbetriebs muss die Heizung ausgeschaltet sein!

1.3.11. Buka

Motori se odlikuju niskom razinom buke. Razina buke svih motora znatno je ispod vrijednosti koje su dopuštene propisima IEC 60034-9. Vrijednosti razine buke (zvučni pritisak L_p i zvučna snaga L_w) za različite veličine motora i polaritete pri nazivnom opterećenju dane su u Tablici 1.23.

1.3.11. Noise

Low noise level is characteristic for these motors. Noise level of all of our motors is significantly below values allowed by directive IEC 60034-9. Values of noise level (sound pressure L_p and sound power L_w) for different motor frame sizes and polarities at rated load are given in the Table 1.23.

1.3.11. Geräusche

Die Motoren zeichnen sich mit einem niedrigen Geräuschpegel aus. Der Geräuschpegel aller Motoren liegt deutlich unter den Werten, die in der Norm IEC 60034-9 vorgeschrieben sind. Die Geräuschpegelwerte (Schalldruckpegel L_p und Schalleistungspegel L_w) für verschiedene Motorbaugrößen und Polzahlen bei der Nennbelastung sind in der Tabelle 1.23. angeführt.

Tablica 1.23. / Table 1.23. / Tabelle 1.23.

IEC	Razina zvučnog tlaka L_p - razina zvučne snage L_w za frekvenciju 50 Hz Level of sound pressure L_p - level of sound power L_w for frequency 50 Hz Schalldruckpegel L_p - Schalleistungspegel L_w für Frequenz 50 Hz							
	2p = 2		2p = 4		2p = 6		2p = 8	
	L_p dB (A)	L_w dB (A)	L_p dB (A)	L_w dB (A)	L_p dB (A)	L_w dB (A)	L_p dB (A)	L_w dB (A)
56	46	58	43	55	-	-	-	-
63	52	64	44	56	40	52	39	50
71	56	68	45	57	42	54	40	52
80	59	71	48	60	44	56	42	54
90	63	75	52	64	46	58	45	57
100	65	77	55	67	50	62	48	60
112	67	79	56	68	55	67	51	63
132	72	84	60	72	58	70	55	67
160	74	87	64	76	62	74	58	70
180	75	88	69	82	66	76	61	74
200	77	90	70	83	65	78	62	75
225	78	91	72	85	65	78	63	76
250	79	92	73	86	67	80	63	76
280	79	92	74	88	69	83	64	78
315	80	94	76	90	71	85	66	80

1.4. Zaštita od korozije i završni premaz

Visoku kvalitetu zaštite od korozije svih metalnih dijelova osigurava dobro pripremljena, pjeskarena i odmašćena površina, te izbor kvalitetnih premaza.

Slobodni kraj vratila i dosjedi zaštićuju se sredstvima za privremenu zaštitu od korozije, a preko pogonskog kraja vratila navučen je plastični tuljak ili mrežica za mehaničku zaštitu tijekom transporta.

Zaštita od korozije za tropsku atmosferu, slane i druge agresivne medije izvodi se na poseban zahtjev.

Klasifikacija okoline i pripadajuće debljine premaza dani su u tablici.

Na poseban zahtjev završni premazi mogu se izvoditi u drugim nijansama.

1.4. Corrosion protection and final coating

High quality corrosion protection of all metal parts ensures well prepared, sand blasted and degreased surface, choice of quality coatings.

Free end shaft and fittings are protected with means for temporary corrosion protection, and there is plastic cover or net for mechanical protection during transport over free end shaft.

Corrosion protection for tropical atmosphere, salt and other aggressive media is available upon request.

Environment classification and thickness of coating are given in table.

Upon special request, final coating can be done in other color tone.

1.4. Korrosionsschutz und Endanstrich

Die hohe Korrosionsschutzqualität aller Metallteile sichert eine gut vorbereitete, sandgestrahlte und entfettete Oberfläche, der Auswahl der Qualitätsanstriche im Einklang mit der Forderungen.

Die freie Wellenende und Passungen schützt man mit den Mitteln für provisorischen Korrosionsschutz und über der Wellenantriebsende ist eine Kunststoffülle oder Schutznetz zwecks mechanisches Schutzes während des Transports aufgezogen.

Der Korrosionsschutz für tropische Umgebungen, salzhaltige oder andere aggressive Medien führt man auf Sonderanfrage aus.

Die Umgebungsklassifizierung und zugehörige Schichtdicke sind in der Tabelle angegeben. Auf Anfrage kann man die Endanstriche auch in anderen Farbtönen ausführen.

Tablica 1.24. / Table 1.24. / Tabelle 1.24.

No. Paint system	Environment load	Motor material	EP	PUR	TTDF
			µm	µm	µm
1.	C3-M	aluminium	N	60	60
		cast iron	80	80	160
2.	C4-M	aluminium	80	80	160
		cast iron	160	80	240
3.	C5M-M	aluminium	160	65	225
		cast iron	240	40	280
4.	C5M-H	aluminium	240	40	280
		cast iron	240	80	320

TTDF	Ukupna debljina suhog sloja u µm	Total thickness of dry film in µm	Trockenfilmgesamtschichtdicke in µm
EP	Epoksi premaz	Epoxy paint	Epoxyanstrich
PUR	Poliuretanski premaz	Polyurethane paint	Poliurethananstrich

1.5. Održavanje

Motori iz proizvodnog programa ukoliko su ispravno montirani i priključeni na izvor napajanja ne zahtijevaju nikakvo posebno održavanje. Povremeno je potrebno provjeriti ventilatorsku kapu kako nečistoće ne bi zatvorile otvore za usis rashladnog zraka i time prouzročila pregrijavanje motora. Budući da su motori opremljeni zatvorenim trajno podmazanim ležajevima za cijeli vijek trajanja, dodatna podmazivanja nisu potrebna, a zamjenu obavljati prema preporuci proizvođača.

KONČAR-MES osigurava raspoloživost rezervnih dijelova unutar perioda do 7 godina uključujući i jamstveni period. Servis proizvoda KONČAR-MES i ostalih proizvođača je moguć je i za proizvode starije od 7 godina uz posebne uvjete.

Kod naručivanja rezervnih dijelova potrebno je navesti slijedeće pozicija i naziv rezervnog dijela, tipska oznaka motora i kodni broj motora. Ostale napomene navedene su u Uputama za rukovanje i održavanje, koje se isporučuju uz motor.

1.6. Pakiranje i transport

Motori veličine 56 – 112 pakiraju se u kartonske kutije. Motori veličine 132 – 315 pakiraju se na drvene palete.

Na poseban zahtjev pakiranje motora može se izvesti i na drugačiji način.

1.5. Maintenance

If properly mounted and connected to the power source, motors from our production program do not need any special maintenance. It is necessary to check fan cap from time to time in order to remove potential aggregated dirt, which can prevent suction of cooling air and cause motor overheating. Since motors are equipped with permanently closed and greased for life bearings, additional re-greasing is not necessary and bearing replacement has to be made according to manufacturer's instructions.

KONČAR-MES ensures availability of spare parts during 7 years including warranty period. Servicing of KONČAR-MES products, together with other producers, is possible also for products older than 7 years with special conditions.

When ordering spare parts, it is necessary to list position and name of spare part, type of motor and code of motor.

Other remarks are mentioned in „Operation & maintenance instructions“ , delivered together with motor.

1.6. Packaging and transportation

Motor frame sizes 56 – 112 are packed in cardboard boxes. Motors frame sizes 132 – 315 are packed on wooden pallets.

On special request, motor packaging can be made in a different manner.

1.5. Instandhaltung

Die Motoren aus unserem Produktionsprogramm, wenn die richtig aufgestellt und auf die Speisequelle angeschlossen sind, verlangen keine besondere Instandhaltung. Regelmäßig soll man die Lüfterhaube überprüfen, so dass die Verunreinigungen nicht die Kühlluftansaugöffnungen verstopfen und dadurch die Motorüberhitzung verursacht wird. Da die Motoren mit geschlossenen, daürgeschmierten Lager ausgerüstet sind, sind keine Nachschmierungen notwendig und den Lageraustausch soll man nach der Herstellerempfehlungen machen.

KONČAR-MES sichert die Verfügbarkeit der Ersatzteile binnen einer Zeitperiode von 7 Jahren einschliesslich der Garantiezeit. Die Reparatur der Produktgegenstände vom KONČAR-MES sowie von anderen Herstellern ist auch für die Produktgegenstände älter als 7 Jahre unter besonderen Bedingungen möglich. Bei der Ersatzteilebestellung ist es notwendig die Positionszahl und Benennung des Ersatzteils, die Motortypenbezeichnung und Artikelnummer anzugeben.

Andere Bemerkungen sind in den Anweisungen für die Handhabung und Instandhaltung, die mit dem Motor geliefert werden, angeführt.

1.6. Verpackung und Transport

Die Motoren der Baugrößen 56 – 112 sind in Kartons verpackt. Die Motoren der Baugrößen 132-315 sind auf den hölzernen Europaletten verpackt.

Auf Sonderanfrage kann man die Verpackung auch auf andere Weise ausführen.

1.7. Dopuštena odstupanja podataka (IEC 60034-1)

Tolerancije elektromehaničkih karakteristika definirane su normom IEC 60034-1 i navedene su u Tablici 1.25 i 1.26.

1.7. Allowed tolerances (IEC 60034-1)

Tolerances of electrical and mechanical characteristics are prescribed by IEC 60034-1 and are listed in the Table 1.25 and 1.26.

1.7. Zulässige Datenabweichungen (IEC 60034-1)

Die Abweichungen der elektromechanischen Charakteristiken sind mit der Norm IEC 60034-1 definiert und in der Tabelle 1.25 und 1.26. angeführt.

Tablica 1.25. / Table 1.25. / Tabelle 1.25

Veličina / Dimension / Größe	Dopušteno odstupanje / Permitted tolerance Zulässige Abweichung
Tolerancija napona i frekvencije / voltage tolerance and frequency tolerance / Spannungs- und Frequenztoleranz	B ± 10% V, +3/-5% Hz
Brzina n / Speed n / Drehzahl n	PN > 1 kW ±20% (ns - nN) PN ≤ 1 kW ±30% (ns - nN)
Korisnost η / Efficiency η / Wirkungsgrad η	PN ≤ 150 kW -0.15(1-η) PN > 150 kW -0.10(1-η)
Faktor snage cos φ / Power factor cos φ / Leistungsfaktor cos φ	-(1-cos φ)/6 min 0.02, max 0.07
Klizanje / Slipping / Schlupf $\frac{(ns - n)}{ns}$	PN ≤ 1 kW ±30% PN > 1 kW ±20%
Struja kratkog spoja I_k / Starting current I _k / Anlaufstrom I _k	20%
Potezni moment M_p / Starting torque M _p / Anlaufmoment M _p	-15% do +25%
Maks. moment M_{max} / Max Torque M _{max} / Kippmoment M _{max}	-10%
Moment inercije J / Moment of inertia J / Trägheitsmoment J	±10%
Buka / Noise / Geräusch	+ 3 dBA

Sve dimenzije motora su u skladu s normom EN 50347 i IEC 60072 i tolerancije glavnih mjera navedene su u Tablici 1.26. Duljine vratila navedene su u tablici dimenzija, a promjeri središnjeg gnijezda su prema EN 50347.

All motor dimensions are in accordance with standard EN 50347 and IEC 60072 and tolerances of motor main dimensions are given in the Table 1.26. The shaft extensions are specified in the dimension tables and centering spigot diameters are acc. to EN 50347.

Alle Motorabmessungen sind im Einklang mit der Normen EN 50347 und IEC 60072 und Toleranzen der Hauptmaßen sind in der Tabelle 1.26. angegeben. Die freien Wellenenden spezifiziert in der Masstabelle und die Durchmesser der Zentriergewinde sind nach DIN EN 50347.

Tablica 1.26. / Table 1.26. / Tabelle 1.2.

Veličina Dimension Hauptmaß	Oznaka Mark Bezeichnung	Dimenzija (mm) Dimensions (mm) Abmessung (mm)	Tolerancija Tolerance Toleranz
Promjer osovine Shaft diameter Wellendurchmesser	D, DA,	≤ 30 30 ÷ > 50	j6 k6 m6
Promjer dosjeda za centriranje na prirubnici Diameter of flange spigot for positioning Flanschzentrierdurchmesser	N		j6
Visina osovine Frame size Achshöhe	H	≤ 250 > 250	- 0,5 mm -1,0 mm
Razmak rupa za montažu na nogama motora Distance between feet mounting holes Montagelöcherabstand auf den Motorfüßen	A, B	≤ 250 > 250 > 500	± 0,75 mm ± 1,00 mm ± 1,50 mm
Promjer rasporeda rupa za montažu na prirubnici Diameter of flange assembly holes Anbaulochkreisdurchmesser auf dem Flansch	M	≤ 200 > 200 > 500	± 0,25 mm ± 0,50 mm ± 1,00 mm
Širina klina Key width Passfederbreite	F, FA		h9

02

**TROFAZNI KAVEZNI
ASINKRONI MOTORI
THREE-PHASE SQUIRREL CAGE
DREIPHASIGE ASYNCHRONMOTOREN
MIT KÄFIGLÄUFER**



2.1. Općenito

Naši trofazni asinkroni kavezni motori potpuno zatvorene izvedbe i hlađeni vlastitim ventilatorom (IC 411) nalaze najširu primjenu u svim dijelovima proizvodnih i procesnih aktivnosti u industriji te u brodogradnji. Projektirani prema visokim zahtjevima moderne pogonske tehnike oni su, radi svoje modularne konstrukcije, s lakoćom prilagodljivi različitim zahtjevima korisnika.

Njihova su ekološka svojstva (niska bučnost i male vibracije, visoka iskoristivost i gotovo 100%-tna reciklabilnost) usklađena s pouzdanošću u svakodnevnoj uporabi, čak i u otežanim radnim i klimatskim uvjetima.

Odlikuju se visokom kvalitetom upotrijebljenih materijala, ležajevima podmazanim za vijek trajanja, završnim premazom otpornim na utjecaje vremena i koroziju te izolacijskim sustavom visoke dielektričke čvrstoće predviđenim za rad preko frekvencijskog pretvarača.

Sve to daje Vam dodatno povjerenje da će Vaši pogonski sustavi opremljeni ovim modernim serijama motora postati još konkurentniji i pouzdaniji.

2.1. General

Our three-phase squirrel cage induction T.E.F.V. (IC411) motors find widest range of application in all segments of manufacturing and processing activities in the industry and shipbuilding. Designed to meet the highest requirements of modern drives technology, they are adaptable to the various customers demands due to their modular design.

Their ecological features (low noise level, low vibrations, high efficiency and almost 100% recyclability) are harmonised with their reliability in everyday use, even under hard working and climate conditions.

They are distinguished by high quality of used materials, life greased bearings, weather and corrosion resistant final coating and high dielectric strength insulation system intended to be fed over by static frequency converter.

All of that gives you additional confidence that your drive system equipped with this modern motor series will become more competitive and reliable.

2.1. Allgemeine Angaben

Unsere dreiphasigen Asynchronmotoren mit Käfigläufer völlig geschlossener Ausführung und mit einem Eigenlüfter gekühlt (IC411), finden breiteste Anwendung in allen Segmenten der Herstellungs- u. Prozessstätigkeiten in der Industrie und im Schiffsbau. Projektiert nach hohen Anforderungen moderner Antriebstechnik, sind die wegen modularer Bauweise mit Leichtigkeit verschiedener Anforderungen des Benutzers adaptierbar. Die ökologischen Eigenschaften der Motoren (geräusch- u. vibrationsarm, hoher Wirkungsgrad und beinahe 100%-ige Entsorgung) harmonisieren mit der Verlässlichkeit bei täglicher Anwendung unter erschwerten Betriebs- u. Umweltverhältnissen. Sie zeichnen sich durch hochwertige eingesetzte Werkstoffe, dauergeschmierte Lager, witterungs- u. korrosionsfesten Endanstrich und das Isolationssystem höher dielektrischer Festigkeit vorgesehen für den Frequenzrichterbetrieb, aus.

All is das gibt Ihnen zusätzliche Sicherheit, dass Ihre Antriebssysteme ausgerüstet mit diesen modernen Motorenbaureihen noch konkurrenzfähiger und verlässlicher sein werden.

Scheme spajanja

Connection diagrams

Schaltschemen

Trofazni jednobrzinski motori / Three phase single speed motors / Eintourige Dreiphasenmotoren		
	NIŽI NAPON (spoj Δ) LOWER VOLTAGE (Δ connection) NIEDRIGE SPANNUNG (Δ Schaltung)	VIŠI NAPON (spoj Y) HIGHER VOLTAGE (Y connection) HÖHERE SPANNUNG (Y Schaltung)
NAMOT U SPOJU D/Y WINDING CONNECTED IN D/Y WICKLUNG GESCHALTET IN D/Y		
SHEMA PRIKLJUČKA NA MREŽU DIAGRAM OF TERMINALS FOR POWER SUPPLY KLEMMENSCHALTPLAN AUFS NETZ		

2.1.1. IE1 trofazni kavezni asinkroni motori - STANDARD

2.1.1. IE1 Three-phase Squirrel cage induction motors - STANDARD

2.1.1. IE1 Dreiphasenasynchronmotoren mit Käfigläufer - STANDARD

Tablica 2.1. / Table 2.1. / Tabelle 2.1.

Standardna izvedba	Standard design	Standardausführung
Serije i veličine: 5AZ 56-160 u siluminskom, tlačno lijevanom orebrenom kućištu s odlivenim nogama 7AZ 90-315 u orebrenom kućištu od sivog lijeva s montažnim nogama.	Motor series and frame sizes: 5AZ 56 – 160 in ribbed die casted aluminum alloy frame, with casted feet 7AZ 90 – 315 in ribbed cast iron frame with dismantable feet.	Baureihen und Baugrößen 5AZ 56 – 160 im gerippten Alu-Druckgussgehäuse mit gegossenen Füßen 7AZ 90 – 315 im gerippten Graugussgehäuse mit angeschraubten Füßen.
Oblici ugradnje : IM B3, B5, B35, B14 i B34 (dva posljednja do uključivo veličine 132)	Mouting arrangements: IM B3, B5, B35, B14 and B34 (last two available up to frame size 132)	Bauformen: IIM B3, B5, B35, B14 und B34 (die zwei letzten bis einschließlich der Bgr.132)
Priključni ormarić: metalni, gledano sa strane pogonskog vratila u oblicima IM B3, B35 i B34 smješten gore uvodnice i čepovi sa „M“ navojem prema tehničkim razjašnjenjima	Terminal box: metal, viewed from drive end side in mounting arrangements IMB3, B35 and B34 situated on top cable glands and cable plugs with „M“ thread according to technical explanations	Klemmenkasten: aus Metall, von der Antriebswellenseite betrachtet in Bauformen IMB3, B35 und B34 oben aufgestellt Kabelverschraubungen und Stopfen mit metrischem Gewinde M nach technischen Erläuterungen
Raspon snaga: 0.06 – 200 kW	Power range: 0.06 – 200 kW	Leistungsbereich: 0.06 – 200 kW
Vrsta pogona: S1; (za okolinu -20°C do +40°C i postav do 1000 m nm.)	Duty type: S1 (for ambient from -20°C to +40°C and altitude up to 1000 m above sea level)	Betriebsart: S1 (für die Umgebung von -20°C bis +40°C und die Aufstellung bis 1000m über den Meeresspiegel)
Napon i frekvencija: 230/400 V ± 10% Δ/Y (do 2,2 kW), 400/690V ± 10% Δ/Y (od 3 kW) i 50 Hz	Voltage and frequency: 230/400 V ± 10% Δ/Y (to 2,2 kW), 400/690V ± 10% Δ/Y (from 3 kW) i 50 Hz	Spannung u.Frequenz: 230/400 V ± 10% /Y (bis 2,2 kW), 400/690V ± 10% /Y (ab 3 kW) i 50 Hz
Iskoristivost: u klasi IE1 prema IEC 60034-30 mjereno prema IEC 60034-2-1	Efficiency: in class IE1 according to IEC 60034-30 agreement measured according to IEC 60034-2-1	Wirkungsgrad: in Wirkungsgradklasse IE1 nach der IEC 60034-30 Vereinbarung gemessen nach IEC 60034-2-1
Broj polova: jednobrzinski motori: 2, 4, 6 i 8 standardno	Number of poles: single-speed motors: 2, 4, 6 and 8 as standard	Polpaarzahl: eintourige Motoren: 2, 4, 6 und 8 standardmä ßig
Stupanj zaštite: IP55	Protection index: IP55	Schutzart: IP55
Klasa izolacije: F (zagrijavanje u B)	Insulation class: F (rise in B)	Isolationsklasse: F (Erwärmung in B)
Ton boje: RAL 5010	Colour tone: RAL 5010	Farbton: RAL 5010



Tablica 2.2. / Table 2.2. / Tabelle 2.2.

2p=2 IE1			3000 min ⁻¹				400V / 50Hz				B3	440V/60Hz/3600 min ⁻¹		
P (kW)	Motor type	n (min ⁻¹)	η (%)	cos φ	I _n (A)	$\frac{I_k}{I_n}$	M _n (Nm)	$\frac{M_k}{M_n}$	$\frac{M_{max}}{M_n}$	J (kgm ²)	m (kg)	P (kW)	n (min ⁻¹)	I _n (A)
0.09	5AZ 56A-2	2810	61	0.81	0.26	3.6	0.3	2.2	2.2	0.00011	3.2	0.09	3370	0.26
0.12	5AZ 56B-2	2820	61	0.8	0.37	3.8	0.4	2.5	2.5	0.00011	3.3	0.12	3380	0.37
0.18	5AZH 56B-2	2730	63	0.84	0.5	4.2	0.6	2.5	2.5	0.00011	3.3	0.2	3280	0.5
0.18	5AZ 63A-2	2810	65.9	0.75	0.52	4.3	0.6	3.3	3.3	0.00015	3.8	0.2	3380	0.52
0.25	5AZ 63B-2	2840	69.7	0.71	0.72	5.1	0.8	3.3	3.8	0.00019	4.2	0.3	3430	0.75
0.37	5AZH 63B-2	2780	70	0.84	0.9	4.2	1.25	2.4	2.6	0.00019	4.3	0.4	3340	0.9
0.37	5AZ 71A-2	2760	63.9	0.8	1	3.8	1.3	2.1	2.3	0.0003	5	0.4	3320	1
0.55	5AZ 71B-2	2770	69	0.82	1.4	4.2	1.9	2.1	2.3	0.0004	5.7	0.6	3320	1.4
0.75	5AZH 71B-2	2760	73	0.77	2	3.7	2.6	2.4	2.4	0.0004	5.7	0.8	3310	2
0.75	5AZ 80A-2	2815	72.1	0.82	1.8	4.8	2.55	2.6	2.8	0.0006	8.3	0.8	3400	1.8
1.1	5AZ 80B-2	2815	75	0.84	2.5	5.1	3.7	2.5	2.6	0.0008	9.5	1.2	3400	2.45
1.5	5AZH 80B-2	2800	77	0.78	3.6	4.6	5	2.9	3	0.0008	9.5	1.7	3360	3.6
1.5	5AZ 90S-2	2820	77.2	0.84	3.3	4.8	5.1	2.4	2.5	0.0014	12	1.7	3410	3.4
2.2	5AZ 90L-2	2820	79.7	0.84	4.7	5.4	7.5	2.8	2.9	0.0018	14.5	2.5	3410	4.7
3	5AZ 100L-2	2860	81.5	0.83	6.2	6.6	10	2.8	3.4	0.0036	21	3.4	3430	6.2
4	5AZH 100L-2	2850	79	0.86	8.5	5.2	13	2.5	2.6	0.0589	23	4.5	3420	8.5
4	5AZ 112M-2	2900	83.1	0.85	8	7.5	13	2.9	3.5	0.0056	26	4.5	3450	8
5.5	5AZH 112M-2	2880	82	0.84	11.5	6.1	18	2.1	2.7	0.0063	31	6.2	3460	11.5
5.5	5AZ 132SA-2	2920	87	0.76	12	7.9	18	2.7	3.5	0.0110	36	6.2	3500	12
7.5	5AZ 132SB-2	2920	88.1	0.81	15	8.5	25	3	3.7	0.0143	43	8.5	3500	15.5
9.5	5AZ 132M-2	2920	87	0.88	17.5	8.5	31	3	3.6	0.1758	56	11	3500	17.5
11	5AZH 132M-2	2920	89	0.85	21	8	35	3	3.6	0.1758	56	12.5	3500	21
11	5AZ 160MA-2	2930	87.6	0.86	21	7.6	36	2.9	3.5	0.0323	72	12.5	3510	20.5
15	5AZ 160MB-2	2930	88.7	0.89	27	8.7	49	3.2	3.8	0.0448	82	17	3510	27
18.5	5AZ 160L-2	2940	89.3	0.9	33	9	60	3.4	3.9	0.0535	99	21	3530	33
22	5AZH 160L-2	2940	90	0.8	43	8.3	70	4	4.5	0.0535	99	25	3530	43
1.5	7AZ 90LR-2	2820	77.2	0.84	3.3	4.8	5.1	2.4	2.5	0.0014	25	1.7	3410	3.4
2.2	7AZ 90L-2	2820	79.7	0.84	4.7	5.4	7.5	2.8	2.9	0.0018	27	2.5	3410	4.7
3	7AZ 100L-2	2860	81.5	0.83	6.2	6.6	10	2.8	3.4	0.0036	38	3.4	3430	6.2
4	7AZH 100L-2	2850	79	0.86	8.5	5.2	13	2.5	2.6	0.0589	40	4.5	3420	8.5
4	7AZ 112M-2	2900	83.1	0.85	8	7.5	13	2.9	3.5	0.0056	48	4.5	3450	8
5.5	7AZH 112M-2	2880	82	0.84	11.5	6.1	18	2.1	2.7	0.0063	53	6.2	3460	11.5
5.5	7AZ 132SA-2	2920	87	0.76	12	7.9	18	2.7	3.5	0.0110	62	6.2	3500	12
7.5	7AZ 132SB-2	2920	88.1	0.81	15	8.5	25	3	3.7	0.0143	67	8.5	3500	15.5
9.5	7AZ 132M-2	2920	87	0.88	17.5	8.5	31	3	3.6	0.1758	84	11	3500	17.5
11	7AZH 132M-2	2920	87.3	0.85	21	8	35	3	3.6	0.1758	88	12.5	3500	21
11	7AZ 160MA-2	2930	87.6	0.86	21	7.6	36	2.9	3.5	0.0323	122	12.5	3510	20.5
15	7AZ 160MB-2	2930	88.7	0.89	27	8.7	49	3.2	3.8	0.0448	132	17	3510	27
18.5	7AZ 160L-2	2940	89.3	0.9	33	9	60	3.4	3.9	0.0535	150	21	3530	33
22	7AZH 160L-2	2940	90	0.8	43	8.3	70	4	4.5	0.0535	150	25	3530	43
22	7AZ 180M-2	2945	89.9	0.84	42.5	8.0	71	3.2	4.3	0.0718	187	25	3535	42.5
30	7AZ 180L-2	2945	91.5	0.86	55.0	7.5	100	3.0	3.5	0.1060	220	33	3535	55.0
30	7AZ 200LA-2	2960	92.0	0.88	53.5	8.3	97	2.5	3	0.1240	250	34	3550	53.5
37	7AZ 200LB-2	2955	91.2	0.9	65	8	120	2.3	2.5	0.1551	275	42	3550	65
45	7AZ 225M-2	2970	91.7	0.89	78.5	7.3	145	2.3	2.8	0.2313	340	50	3540	78.5
55	7AZ 250M-2	2970	93.2	0.89	95.5	7.2	177	2.4	2.5	0.3784	430	62	3550	95.5
75	7AZ 280S-2	2975	93.8	0.85	135	9	241	2.7	2.9	0.6105	605	85	3550	135
90	7AZ 280M-2	2975	94.1	0.82	168	8	289	2.6	2.8	0.7326	660	105	3550	168
110	7AZ 315S-2	2985	94.3	0.9	185	9.2	352	2.2	2.6	1.4432	940	124	3580	185
132	7AZ 315M-2	2980	94.6	0.9	223	8.4	423	1.9	2.4	1.7319	1015	149	3575	223
160	7AZ 315LA-2	2985	94.8	0.9	270	11.5	512	2.4	2.6	2.0992	1100	180	3575	270
200	7AZ 315LXB-2	2985	95	0.91	330	9.8	640	2.1	2.5	2.5191	1220	225	3580	330



Tablica 2.3. / Table 2.3. / Tabelle 2.3.

2p=4			1500 min ⁻¹			400V / 50Hz					B3	440V/60Hz/1800 min ⁻¹		
P (kW)	Motor type	n (min ⁻¹)	η (%)	cos φ	I _n (A)	$\frac{I_k}{I_n}$	M _n (Nm)	$\frac{M_k}{M_n}$	$\frac{M_{max}}{M_n}$	J (kgm ²)	m (kg)	P (kW)	n (min ⁻¹)	In (A)
0.06	5AZ 56A-4	1415	58	0.62	0.25	2.8	0.4	2.1	2.1	0.0001791	3.1	0.06	1700	0.25
0.09	5AZ 56B-4	1400	58	0.6	0.38	2.6	0.6	1.9	1.9	0.0001791	3.1	0.09	1680	0.35
0.12	5AZH 56B-4	1350	58	0.7	0.41	3	0.85	1.9	1.9	0.0001791	3.2	0.12	1620	0.41
0.12	5AZ 63A-4	1360	58	0.75	0.44	3	0.85	2	2.1	0.0002211	3.4	0.12	1630	0.44
0.18	5AZ 63B-4	1370	60	0.72	0.6	3.3	1.3	2.2	2.4	0.0002948	4.2	0.2	1640	0.6
0.25	5AZH 63B-4	1310	59	0.78	0.8	2.7	1.8	1.8	1.8	0.0002948	4.2	0.3	1570	0.8
0.25	5AZ 71A-4	1370	59	0.71	0.82	3.3	1.75	2	2.2	0.0005	4.8	0.3	1640	0.82
0.37	5AZ 71B-4	1370	66	0.73	1.1	3.4	2.5	2	2.2	0.0006	5.6	0.4	1640	1.1
0.55	5AZ 80A-4	1390	70	0.74	1.5	4	3.8	2	2.2	0.0010	8	0.6	1670	1.5
0.75	5AZ 80B-4	1390	72.1	0.75	1.9	4.3	5.1	2.3	2.4	0.0013	9.2	0.8	1670	1.9
1.1	5AZ 90S-4	1385	75	0.81	2.6	4.2	7.6	2.2	2.4	0.0024	11.3	1.2	1660	2.7
1.5	5AZ 90L-4	1380	77.2	0.8	3.5	4.4	10.5	2.1	2.2	0.0032	13.8	1.7	1655	3.5
2.2	5AZH 90LC-4	1410	75.0	0.78	5.4	4.4	15	2.5	2.6	0.0036	16	2.5	1630	5.4
2.2	5AZ 100LA-4	1410	79.7	0.83	4.8	5.2	14.9	2.2	2.7	0.0056	19.5	2.5	1690	4.8
3	5AZ 100LB-4	1410	81.5	0.8	6.6	5.6	20	2.4	2.7	0.0071	23	3.4	1690	6.6
3.5	5AZH 100LB-4	1410	82.0	0.77	8	5.8	25	2.7	2.9	0.0071	23	4	1690	8
4	5AZ 112M-4	1435	83.1	0.8	8.5	6.9	27	2.7	3.1	0.0122	30	4.5	1710	8.5
5.5	5AZH 112M-4	1410	82.0	0.78	12.5	5.5	35	2.7	3	0.0122	30	6.2	1690	12.5
5.5	5AZ 132S-4	1435	84.7	0.85	11	6.1	36.6	2.4	3	0.0202	39	6.2	1720	11.5
7.5	5AZ 132M-4	1440	86	0.76	16.5	6.6	49.7	3.1	3.5	0.0276	48	8.5	1720	16.5
9.5	5AZ 132MA-4	1440	87	0.81	19.5	6.7	63	2.8	3.7	0.0349	56	11	1720	19.5
11	5AZH 132MA-4	1430	87	0.82	22	6.6	75	2.7	2.9	0.4060	62	12.5	1720	22
11	5AZ 160M-4	1465	87.6	0.78	22.5	7.4	72	3.4	3.8	0.0612	78	12.5	1750	22.5
15	5AZ 160L-4	1460	88.7	0.86	28	6.9	98	2.8	3.3	0.0822	96	17	1750	28
1.1	7AZ 90LR-4	1385	75	0.81	2.6	4.2	7.6	2.2	2.4	0.0024	26	1.2	1660	2.7
1.5	7AZ 90L-4	1380	77.2	0.8	3.5	4.4	10.5	2.1	2.2	0.0032	28.4	1.7	1655	3.5
2.2	7AZH 90LC-4	1410	75.0	0.78	5.4	4.4	15	2.5	2.6	0.0036	34.7	2.5	1630	5.4
2.2	7AZ 100LA-4	1410	79.7	0.83	4.8	5.2	14.9	2.2	2.7	0.0056	38	2.5	1690	4.8
3	7AZ 100LB-4	1410	81.5	0.8	6.6	5.6	20	2.4	2.7	0.0071	41	3.4	1690	6.6
3.5	7AZH 100LB-4	1410	82.0	0.77	8	5.8	25	2.7	2.9	0.0071	41	4	1690	8
4	7AZ 112M-4	1435	83.1	0.8	8.5	6.9	27	2.7	3.1	0.0122	52	4.5	1710	8.5
5.5	7AZH 112M-4	1410	82.0	0.78	12.5	5.5	35	2.7	3	0.0122	52	6.2	1690	12.5
5.5	7AZ 132S-4	1435	84.7	0.85	11	6.1	36.6	2.4	3	0.0202	72	6.2	1720	11.5
7.5	7AZ 132M-4	1440	86	0.76	16.5	6.6	49.7	3.1	3.5	0.0276	80	8.5	1720	16.5
9.5	7AZ 132MA-4	1440	87	0.81	19.5	6.7	63	2.8	3.7	0.0349	89	11	1720	19.5
11	7AZH 132MA-4	1430	87	0.82	22	6.6	75	2.7	2.9	0.4060	95	12.5	1720	22
11	7AZ 160M-4	1465	87.6	0.78	22.5	7.4	72	3.4	3.8	0.0612	135	12.5	1750	22.5
15	7AZ 160L-4	1460	88.7	0.86	28	6.9	98	2.8	3.3	0.0822	150	17	1750	28
18.5	7AZ 180M-4	1460	89.3	0.83	35	7.3	121	2.9	3	0.1262	185	21	1750	35
22	7AZ 180L-4	1460	89.9	0.84	41	7.3	144	2.9	3	0.1514	193	25	1750	41
30	7AZ 200L-4	1465	90.7	0.85	56	7.5	195	3.2	3.2	0.2430	270	34	1760	56
37	7AZ 225S-4	1475	91.2	0.85	67.5	7	240	2.8	2.9	0.3825	340	42	1780	67.5
45	7AZ 225M-4	1475	91.7	0.83	84	6.9	291	3.3	3.3	0.4623	363	52	1780	84
55	7AZ 250M-4	1480	92.1	0.86	100	7.3	355	2.4	2.8	0.7180	481	62	1780	100
75	7AZ 280S-4	1485	92.7	0.83	142	6.9	482	2.4	2.8	1.1864	620	85	1780	142
90	7AZ 280M-4	1485	94.2	0.84	164	6.8	579	2.1	2.5	1.4240	680	103	1780	164
110	7AZ 315S-4	1485	94.5	0.84	200	6	707	1.9	2.2	2.5126	950	124	1785	200
132	7AZ 315M-4	1485	94.7	0.84	239	6.7	849	2	2.2	3.0988	1050	149	1785	239
160	7AZ 315LA-4	1490	94.9	0.83	290	7.2	1026	2	2.3	3.6851	1230	180	1785	290
200	7AZ 315LXB-4	1490	95.1	0.81	370	7.1	1282	2	2.3	4.4387	1300	225	1785	370
110	7AZ 315S-4	1485	94.5	0.84	200	6	707	1.9	2.2	2.5126	950	124	1785	200
132	7AZ 315M-4	1485	94.7	0.84	239	6.7	849	2	2.2	3.0988	1050	149	1785	239
160	7AZ 315LA-4	1490	94.9	0.83	290	7.2	1026	2	2.3	3.6851	1230	180	1785	290
200	7AZ 315LXB-4	1490	95.1	0.81	370	7.1	1282	2	2.3	4.4387	1300	225	1785	370

Tablica 2.4. / Table 2.4. / Tabelle 2.4.

2p=6			1000 min ⁻¹				400V / 50Hz				B3	440V/60Hz/1200 min ⁻¹		
P (kW)	Motor type	n (min ⁻¹)	η (%)	cos φ	I _n (A)	$\frac{I_k}{I_n}$	M _n (Nm)	$\frac{M_k}{M_n}$	$\frac{M_{max}}{M_n}$	J (kgm ²)	m (kg)	P (kW)	n (min ⁻¹)	I _n (A)
0.05	5AZ 56B-6	850	43	0.62	0.35	2.2	0.55	2.2	2.3	0.0001791	3.3	0.05	1020	0.35
0.07	5AZ 63A-6	850	43	0.62	0.42	2.2	0.8	2.2	2.3	0.0002211	3.6	0.07	1020	0.42
0.12	5AZ 63B-6	860	43	0.62	0.8	2.2	1.3	2.2	2.3	0.0002948	4.1	0.12	1030	0.8
0.18	5AZ 71A-6	910	45.5	0.66	0.75	2.5	2	1.8	2.1	0.0005	5.5	0.2	1020	0.7
0.25	5AZ 71B-6	900	52.1	0.68	0.86	2.9	2.7	1.9	2.1	0.0010	5.7	0.3	1080	0.86
0.37	5AZ 80A-6	910	59.7	0.74	1.2	3.4	3.9	1.8	2	0.0018	7.8	0.4	1080	1.2
0.55	5AZ 80B-6	915	65.8	0.71	1.7	3.4	5.7	2	2.3	0.0022	9	0.6	1080	1.7
0.75	5AZH 80C-6	900	69	0.73	2.1	3.7	8	2	2.3	0.0023	10.5	0.8	1080	2.1
0.75	5AZ 90S-6	900	70	0.67	2.3	3.2	8	1.9	2.1	0.0024	11.5	0.8	1080	2.4
1.1	5AZ 90L-6	900	72.9	0.68	3.2	3.2	11.8	2.1	2.2	0.0031	15	1.2	1080	3.3
1.5	5AZ 100L-6	935	75.2	0.71	3.8	4.8	15.3	2.4	2.8	0.0104	20.5	1.7	1125	3.8
2.2	5AZ 112M-6	950	77.7	0.71	5.7	5.3	22	2.5	2.9	0.0148	25	2.5	1130	5.7
3	5AZH 112MA-6	950	79	0.72	7.5	3.4	30	2.7	3.3	0.0188	35	3.4	1140	7.5
3	5AZ 132S-6	955	79.7	0.73	7.2	4.9	30	2.1	2.5	0.0277	36	3.4	1130	7.2
4	5AZ 132MA-6	955	81.4	0.72	9.8	5.5	40	2.4	2.7	0.0378	45	4.5	1140	9.8
5.5	5AZ 132MB-6	955	83.1	0.74	12.8	5.8	55	2.6	3	0.0453	53	6.2	1140	12.8
7.5	5AZ 160M-6	965	84.7	0.81	15.7	7.5	74	2.8	3.5	0.0925	94	8.2	1160	15.7
11	5AZ 160L-6	965	86.4	0.82	22	7.6	109	2.8	3.5	0.1261	110	12.5	1160	22
0.75	7AZ 90LR-6	900	70	0.67	2.3	3.2	8	1.9	2.1	0.0024	26	0.8	1080	2.4
1.1	7AZ 90L-6	900	72.9	0.68	3.2	3.2	11.8	2.1	2.2	0.0031	30	1.2	1080	3.3
1.5	7AZ 100L-6	935	75.2	0.71	3.8	4.8	15	2.4	2.8	0.0104	39	1.7	1125	3.8
2.2	7AZ 112M-6	950	77.7	0.71	5.7	5.3	22	2.5	2.9	0.0148	48	2.5	1130	5.7
3	7AZH 112MA-6	950	79	0.72	7.5	3.4	30	2.7	3.3	0.0188	58	3.4	1140	7.5
3	7AZ 132S-6	955	79.7	0.73	7.2	4.9	30	2.1	2.5	0.0277	71	3.4	1130	7.2
4	7AZ 132MA-6	955	81.4	0.72	9.8	5.5	40	2.4	2.7	0.0378	76	4.5	1140	9.8
5.5	7AZ 132MB-6	955	83.1	0.74	12.8	5.8	55	2.6	3	0.0453	85	6.2	1140	12.8
7.5	7AZ 160M-6	965	84.7	0.81	15.7	7.5	74	2.8	3.5	0.0925	140	8.2	1160	15.7
11	7AZ 160L-6	965	86.4	0.82	22	7.6	109	2.8	3.5	0.1261	154	12.5	1160	22
15	7AZ 180L-6	975	87.7	0.81	29.5	8.1	147	2.7	3.8	0.1909	202	17	1160	29.5
18.5	7AZ 180LA-6	975	88.0	0.80	37.0	7.7	180	2.4	3.3	0.2386	220	21	1170	37.0
18.5	7AZ 200LA-6	970	88.6	0.78	38.5	6.6	182	2.2	2.5	0.2771	255	21	1170	38.5
22	7AZ 200LB-6	975	89.2	0.8	44.5	6.1	215	2.2	2.7	0.3192	278	25	1170	44.5
30	7AZ 225M-6	980	91.7	0.8	59	6.9	292	3	3.1	0.7262	370	34	1170	59
37	7AZ 250M-6	985	92.2	0.78	74	7	359	3.1	3.4	1.0004	470	42	1180	74
45	7AZ 280S-6	985	91.4	0.78	91	6	436	2.8	3	1.4679	610	50	1180	91
55	7AZ 280M-6	985	93.1	0.77	110	6	533	2.8	3	1.7610	645	62	1180	110
75	7AZ 315S-6	990	94.6	0.82	139	7.6	723	2.6	2.6	4.4698	950	84	1185	139
90	7AZ 315M-6	990	94.9	0.83	165	7.0	868	2.4	2.4	5.5127	1035	101	1185	165
110	7AZ 315LA-6	995	95.1	0.79	211	7.3	1056	2.5	2.5	6.7047	1180	124	1190	211
132	7AZ 315LXB-6	995	95.4	0.79	252	7.2	1267	2.2	2.2	8.1946	1300	149	1190	252

Tablica 2.5. / Table 2.5. / Tabelle 2.5.

2p=8			400V / 50Hz				750 min ⁻¹				B3	440V/60Hz/900 min ⁻¹		
P (kW)	Motor type	n (min ⁻¹)	η (%)	cos φ	I _n (A)	$\frac{I_k}{I_n}$	M _n (Nm)	$\frac{M_k}{M_n}$	$\frac{M_{max}}{M_n}$	J (kgm ²)	m (kg)	P (kW)	n (min ⁻¹)	I _n (A)
0.03	5AZ 56B-8	670	30	0.5	0.35	1.8	0.45	3.3	3.5	0.0001791	3.2	0.03	800	0.35
0.06	5AZ 63B-8	640	35	0.6	0.5	1.9	0.9	2.5	2.6	0.0002948	4.3	0.06	770	0.5
0.09	5AZH 63C-8	620	40	0.6	0.62	1.8	1.4	1.9	2	0.000355	5	0.09	750	0.62
0.09	5AZ 71A-8	690	44.7	0.58	0.5	2.2	1.2	1.9	2.2	0.0007	4.7	0.10	830	0.5
0.12	5AZ 71B-8	690	50.7	0.56	0.6	2.4	1.7	2	2.3	0.0010	5.2	0.14	830	0.6
0.18	5AZH 71C-8	670	45.9	0.62	0.82	2.4	2.6	1.9	2.1	0.0012	6	0.20	810	0.82
0.18	5AZ 80A-8	690	45.9	0.66	0.8	2.7	2.5	1.8	2.3	0.0018	7.7	0.20	830	0.8
0.25	5AZ 80B-8	680	50.6	0.68	1	2.5	3.5	1.5	1.8	0.0022	8.9	0.30	820	1
0.37	5AZ 90S-8	680	56.1	0.56	1.7	2.2	5.2	1.6	1.8	0.0028	11.4	0.40	820	1.7
0.55	5AZ 90L-8	680	61.7	0.55	2.3	2.7	7.7	2	2.1	0.0031	13.7	0.60	820	2.3
0.75	5AZH 90LC-8	660	63	0.61	2.9	2.7	10.9	1.9	2	0.0042	16	0.80	790	2.9
0.75	5AZ 100LA-8	700	66.2	0.64	2.55	3.1	10.2	1.6	2	0.0078	17	0.8	840	2.55
1.1	5AZ 100LB-8	700	70.8	0.64	3.5	3.7	15	2.2	2.4	0.0104	20.5	1.20	840	3.5
1.5	5AZ 112M-8	700	74.1	0.66	4.4	4	20.5	1.9	2.2	0.0148	24.7	1.70	840	4.4
2.2	5AZH 112MA-8	700	76	0.68	6.3	4.2	30.0	1.9	2.5	0.0236	35	2.50	840	6.3
2.2	5AZ 132S-8	690	77.6	0.75	5.4	3.9	30.4	1.9	2.1	0.0262	39	2.50	830	5.4
3	5AZ 132M-8	690	80	0.76	7.1	4.2	41.5	2.1	2.4	0.0365	48	3.40	830	7.1
4	5AZ 160MA-8	715	84.8	0.74	9.2	5.1	53.4	2	2.6	0.0791	76	4.50	860	9.2
5.5	5AZ 160MB-8	715	83.8	0.75	12.5	5.1	73.5	2	2.7	0.1044	84	6.20	860	12.5
7.5	5AZ 160L-8	720	85.3	0.78	16.2	5	99.5	2	2.6	0.1423	100	8.50	865	16.2
0.37	7AZ 90LR-8	680	56.1	0.56	1.7	2.2	5.2	1.6	1.8	0.0028	26	0.40	820	1.7
0.55	7AZ 90L-8	680	61.7	0.55	2.3	2.7	7.7	2	2.1	0.0031	28	0.60	820	2.3
0.75	7AZH 90LC-8	660	63	0.61	2.9	2.7	10.9	1.9	2	0.0042	34.5	0.80	790	2.9
0.75	7AZ 100LA-8	700	66.2	0.64	2.55	3.1	10.2	1.6	2	0.0078	36	0.8	840	2.55
1.1	7AZ 100LB-8	700	70.8	0.64	3.5	3.7	15	2.2	2.4	0.0104	39	1.20	840	3.5
1.5	7AZ 112M-8	700	74.1	0.66	4.4	4	20.5	1.9	2.2	0.0148	48	1.70	840	4.4
2.2	7AZH 112MA-8	700	76	0.68	6.3	4.2	30.0	1.9	2.5	0.0236	58	2.50	840	6.3
2.2	7AZ 132S-8	690	77.6	0.75	5.4	3.9	30.4	1.9	2.1	0.0262	65	2.49	830	5.4
3	7AZ 132M-8	690	80	0.76	7.1	4.2	41.5	2.1	2.4	0.0365	72	3.40	830	7.1
4	7AZ 160MA-8	715	84.8	0.74	9.2	5.1	53.4	2	2.6	0.0791	118	4.50	860	9.2
5.5	7AZ 160MB-8	715	83.8	0.75	12.5	5.1	73.5	2	2.7	0.1044	141	6.20	860	12.5
7.5	7AZ 160L-8	720	85.3	0.78	16.2	5	99.5	2	2.6	0.1423	160	8.50	865	16.2
11	7AZ 180L-8	725	88.6	0.77	23	6	145	2.2	2.8	0.2371	200	15.50	870	23
15	7AZ 180LA-8	720	88.6	0.8	34	6.4	200	2.2	3.3	0.2800	220	17.00	860	34
15	7AZ 200L-8	730	89.6	0.74	32.5	5.9	196	2.1	2.8	0.4289	275	17.00	875	32.5
18.5	7AZ 225S-8	735	90.1	0.71	41	7.4	242	2.5	3.6	0.6040	325	21.00	880	41
22	7AZ 225M-8	735	90.6	0.75	46	7.3	286	2.2	2.9	0.7297	370	25.00	880	46
30	7AZ 250M-8	735	91.3	0.76	62	6.7	390	2	2.5	1.2449	460	34.00	880	62
37	7AZ 280S-8	735	91.8	0.78	74	6.1	481	1.9	2.4	1.9663	625	42.00	880	74
45	7AZ 280M-8	740	92.2	0.74	94	6.9	581	2.2	2.6	2.3594	660	50.00	890	94
55	7AZ 315S-8	745	92.5	0.78	109	8.9	705	2	2.4	4.5082	930	62.00	895	109
75	7AZ 315M-8	745	93.1	0.83	140	9.2	961	2.1	2.5	5.5602	1090	85.00	895	140
90	7AZ 315LA-8	745	93.4	0.8	173	9.3	1154	2.1	2.5	6.7604	1170	102.00	895	173
110	7AZ 315LB-8	745	93.7	0.8	211	9.3	1410	2.1	2.5	8.2627	1290	124.00	895	211

Motori s oznakom H u tipskoj oznaci su motori istih priključnih mjera kao motori osnovne izvedbe, ali povećanih nazivnih snaga s obzirom na nazivne snage koje propisuje IEC 60072-1. Izolacijski sustav primijenjen u tim motorima je toplinske klase F s dopuštenim zagrijavanjem klase F.

Motors having letter H in motor type designation are motors with the same mounting dimensions as motors of basic design, but with increased power in comparison with standard IEC 60072-1. Insulation system applied in this motors is for temperature class F with permissible temperature rise for class F.

Die Motoren mit dem Buchstabe H in der Typenbezeichnung sind die Motoren gleicher Anbaumaßen wie die Motoren der Grundausführung aber mit progressiven Nennleistungen bezüglich auf die Nennleistungen nach IEC 60072-1. Das eingebaute Isolationssystem in diesen Motoren befindet sich in der Wärmeklasse F mit zulässiger Erwärmung der Wärmeklasse F.

Izračun nazivnog momenta

Equation for rated torque calculation

Berechnung des Nennmoments :

$$M = \frac{P \cdot 9550}{n}$$

M – nazivni moment (Nm)

P - snaga (kW)

n - brzina (min⁻¹)

I_k/I_n - odnos struja kod pokretanja (odnos struje kratkog spoja i nazivne struje kod nazivnog momenta)

M_k/M_n - odnos momenta kod pokretanja (odnos momenta u kratkom spoju i nazivnog momenta motora)

M_{max}/M_n - odnos maksimalnog momenta i nazivnog momenta motora

Napomena: Ostale podatke za 440 V, 60 Hz koristiti iz tablice za 400 V, 50 Hz.

M – rated torque (Nm)

P – power (kW)

n – motor revolving speed (rpm)

I_k/I_n - ratio of currents at starting (ratio between locked rotor current and full load current)

M_k/M_n - ratio of torques at starting (ratio between locked rotor torque and full load torque)

M_{max}/M_n - ratio between breakdown torque and full load torque

Remark: Other data for 440V, 60 Hz can be taken from tables for 400V, 50 Hz

M – Nennmoment (Nm)

P - Nennleistung (kW)

n – Nenndrehzahl (U/min)

I_k/I_n - Startverhältnis der Ströme (Verhältnis des Anlaufs- u. Nennstroms beim Nennmoment)

M_k/M_n - Startverhältnis der Momente

(Verhältnis des Anlaufs- u. Nennmoments)

M_{max}/M_n - Verhältnis des Kipp- u. Nennmoments

Bemerkung: Andere Daten für 440V,60Hz bitte der Tabelle für 400V, 50 Hz entnehmen

2.1.2. IE2 trofazni kavezni asinkroni motori - HIGH

2.1.2. IE2 Three-phase squirrel cage induction motors - HIGH

2.1.2. IE2 Dreiphasenasynchronmotoren mit Käfigläufer - HIGH

Tablica 2.6. / Table 2.6. / Tabelle 2.6.

Standardna izvedba	Standard design	Standardausführung
Serije i veličine: 5AZ 56-160 u siluminskom, tlačno lijevanom orebrenom kućištu s odlivenim nogama 7AZ 90-315 u orebrenom kućištu od sivog lijeva s montažnim nogama.	Motor series and frame sizes: <i>5AZ 56 – 160 in ribbed die casted aluminum alloy frame, with casted feet 7AZ 90 – 315 in ribbed cast iron frame with dismantable feet.</i>	Baureihen und Baugrößen 5AZ 56 – 160 im gerippten Alu-Druckgussgehäuse mit gegossenen Füßen 7AZ 90 – 315 im gerippten Graugussgehäuse mit angeschraubten Füßen.
Oblici ugradnje : IM B3, B5, B35, B14 i B34 (dva posljednja do uključivo veličine 132)	Mouting arrangements: <i>IM B3, B5, B35, B14 and B34 (last two available up to frame size 132)</i>	Bauformen: IIM B3, B5, B35, B14 und B34 (die zwei letzten bis einschließlich der Bgr.132)
Priključni ormarić: metalni, gledano sa strane pogonskog vratila u oblicima IM B3, B35 i B34 smješten gore uvodnice i čepovi sa „M“ navojem prema tehničkim razjašnjenjima	Terminal box: <i>metal, viewed from drive end side in mounting arrangements IMB3, B35 and B34 situated on top cable glands and cable plugs with „M“ thread according to technical explanations</i>	Klemmenkasten: aus Metall, von der Antriebswellenseite betrachtet in Bauformen IMB3, B35 und B34 oben aufgestellt, Kabelverschraubungen und Stopfen mit metrischem Gewinde M nach technischen Erläuterungen
Raspon snaga: 0.06 – 200 kW	Power range: <i>0.06 – 200 kW</i>	Leistungsbereich: 0.06 – 200 kW
Vrsta pogona: S1; (za okolinu -20°C do +40°C i postav do 1000 m nm.)	Duty type: <i>S1 (for ambient from -20°C to +40°C and altitude up to 1000 m above sea level)</i>	Betriebsart: S1 (für die Umgebung von -20°C bis +40°C und die Aufstellung bis 1000m über den Meeresspiegel)
Napon i frekvencija: 230/400 V ± 10% Δ/Y (do 2,2 kW), 400/690V ± 10% Δ/Y (od 3 kW) i 50 Hz	Voltage and frequency: <i>230/400 V ± 10% Δ/Y (to 2,2 kW), 400/690V ± 10% Δ/Y (from 3 kW) i 50 Hz</i>	Spannung u.Frequenz: 230/400 V ± 10% /Y (bis 2,2 kW), 400/690V ± 10% /Y (ab 3 kW) i 50 Hz
Iskoristivost: u klasi IE2 prema IEC 60034-30 mjerenje prema IEC 60034-2-1	Efficiency: <i>in class IE2 according to IEC 60034-30 agreement measurement according to IEC 60034-2-1</i>	Wirkungsgrad: in Wirkungsgradklasse IE2 nach der IEC 60034-30 Vereinbarung gemessen nach IEC 60034-2-1
Broj polova: jednobrzinski motori: 2, 4, 6 i 8 standardno	Number of poles: <i>single-speed motors: 2, 4, 6 and 8 as standard</i>	Polpaarzahl: eintourige Motoren: 2, 4, 6 und 8 standardmäßig
Stupanj zaštite: IP55	Protection index: IP55	Schutzart: IP55
Klasa izolacije: F (zagrijavanje u B)	Insulation class: <i>F (rise in B)</i>	Isolationsklasse: F (Erwärmung in B)
Ton boje: RAL 5010	Colour tone: RAL 5010	Farbton: RAL 5010

IE2

Tablica 2.7. / Table 2.7. / Tabelle 2.7.

2p=2 IE2			3000 min ⁻¹				400V / 50Hz				B3		
P (kW)	Motor type	n (min ⁻¹)	η 100% (%)	η 75% (%)	η 50% (%)	cos φ	I _n (A)	$\frac{I_k}{I_n}$	M _n (Nm)	$\frac{M_k}{M_n}$	$\frac{M_{max}}{M_n}$	J (kgm ²)	m (kg)
0.18	E5AZ 63A-2	2810	65.9	61.5	55.4	0.75	0.52	4.3	0.6	3.3	3.3	0.00015	3.8
0.25	E5AZ 63B-2	2840	69.7	64.9	58.6	0.71	0.72	5.1	0.8	3.3	3.8	0.00019	4.2
0.37	E5AZ 71A-2	2750	69.5	69.1	64.5	0.8	0.95	3.8	1.3	2.1	2.3	0.0003	5
0.55	E5AZ 71B-2	2770	74.1	73.2	68.4	0.8	1.3	4.4	1.9	2.7	2.8	0.0004	5.7
0.75	E5AZ 80A-2	2830	77.4	77.3	74.4	0.82	1.7	5.2	2.5	2.6	2.9	0.0006	8.3
1.1	E5AZ 80B-2	2840	82.7	82.7	81.9	0.8	2.4	5.8	3.7	2.9	3.2	0.0008	9.5
1.5	E5AZ 90S-2	2840	81.3	81.4	78.8	0.78	3.4	5.5	5	2.8	3.4	0.0014	12
2.2	E5AZ 90L-2	2830	83.2	83.5	81	0.82	4.65	6	7.5	3.1	3.2	0.0018	14.5
3	E5AZ 100L-2	2880	84.6	83	80.6	0.85	6	6.9	10	3.5	3.8	0.0036	21
4	E5AZ 112M-2	2910	85.8	85.3	83.3	0.83	8.1	8	13.2	3.5	3.5	0.0056	26
5.5	E5AZ 132SA-2	2920	87	86.1	82.8	0.76	12	7.9	18	2.7	3.5	0.0110	36
7.5	E5AZ 132SB-2	2920	88.1	85.6	83.2	0.81	15	8.5	25	3	3.7	0.0143	43
11	E5AZ 160MA-2	2945	89.4	88.5	85.5	0.84	21	7.9	36	3.9	4.3	0.0323	72
15	E5AZ 160MB-2	2950	90.3	89.9	88	0.86	27.8	9.6	49	3.8	4.1	0.0448	82
18.5	E5AZ 160L-2	2955	90.9	90.4	88.7	0.86	34	9.7	60	3	3.5	0.0535	99
1.5	E7AZ 90LR-2	2840	81.3	81.4	78.8	0.78	3.4	5.5	5	2.8	3.4	0.0014	25
2.2	E7AZ 90L-2	2830	83.2	83.5	81	0.82	4.65	6	7.5	3.1	3.2	0.0018	27
3	E7AZ 100L-2	2880	84.6	83	80.6	0.85	6	6.9	10	3.5	3.8	0.0036	38
4	E7AZ 112M-2	2910	85.8	85.3	83.3	0.83	8.1	8	13.2	3.5	3.5	0.0056	48
5.5	E7AZ 132SA-2	2920	87	86.1	82.8	0.76	12	7.9	18	2.7	3.5	0.0110	62
7.5	E7AZ 132SB-2	2920	88.1	85.6	83.2	0.81	15	8.5	25	3	3.7	0.0143	67
11	E7AZ 160MA-2	2945	89.4	88.5	85.5	0.84	21	7.9	36	3.9	4.3	0.0323	122
15	E7AZ 160MB-2	2950	90.3	89.9	88	0.86	27.8	9.6	49	3.8	4.1	0.0448	132
18.5	E7AZ 160L-2	2955	90.9	90.4	88.7	0.86	34	9.7	60	3	3.5	0.0535	137
22	E7AZ 180M-2	2935	91.3	90.9	88.7	0.87	39.9	7.4	72	3.2	3.8	0.0718	187
30	E7AZ 200LA-2	2960	92	91.8	90.5	0.88	53.5	8.3	97	2.5	3	0.1240	250
37	E7AZ 200LB-2	2955	92.5	92.5	91.7	0.9	64	8.3	120	2.6	3	0.1551	275
45	E7AZ 225M-2	2970	92.9	92.9	91.9	0.89	78.5	7.3	145	2.3	2.8	0.2313	340
55	E7AZ 250M-2	2970	93.2	93.1	92.4	0.89	95.5	7.2	177	2.4	2.5	0.3784	430
75	E7AZ 280S-2	2975	93.8	93.8	92.6	0.85	135	9	241	2.7	2.9	0.6105	605
90	E7AZ 280M-2	2975	94.1	94.1	92.5	0.82	168	8	289	2.6	2.8	0.7326	660
110	E7AZ 315S-2	2985	95.2	94.5	93.5	0.9	185	9.2	352	2.2	2.6	1.4432	940
132	E7AZ 315M-2	2980	94.6	94	92.9	0.9	223	8.4	423	1.9	2.4	1.7319	1015
160	E7AZ 315LA-2	2985	94.8	94.4	93.5	0.9	270	11.5	512	2.4	2.6	2.0992	1100
200	E7AZ 315LXB-2	2985	95.8	95.4	94.7	0.91	330	9.8	640	2.1	2.5	2.5191	1220

Tablica 2.8. / Table 2.8. / Tabelle 2.8.

2p=4 IE2			1500 min ⁻¹				400V / 50Hz				B3		
P (kW)	Motor type	n (min ⁻¹)	η 100% (%)	η 75% (%)	η 50% (%)	cos φ	I _n (A)	$\frac{I_k}{I_n}$	M _n (Nm)	$\frac{M_k}{M_n}$	$\frac{M_{max}}{M_n}$	J (kgm ²)	m (kg)
0.12	E5AZ 63A-4	1370	59.1	57.5	51.2	0.69	0.42	3	0.84	1.9	2.1	0.0002211	3.7
0.18	E5AZ 63B-4	1365	64.7	63.3	57.8	0.68	0.59	3.1	1.26	2.1	2.3	0.0002948	4.2
0.25	E5AZ 71A-4	1360	68.5	62.3	54.1	0.72	0.73	3.1	1.8	1.7	2	0.0005	4.8
0.37	E5AZ 71B-4	1400	77.3	76.0	71.0	0.71	0.97	4.5	2.5	2.5	2.7	0.0007932	6.8
0.55	E5AZ 80A-4	1400	77.1	76.1	73.6	0.71	1.45	4.2	3.7	2.3	2.4	0.0010	8
0.75	E5AZ 80B-4	1400	79.6	79.7	77.9	0.72	1.88	4.5	5.1	2.5	2.6	0.0016	10.5
1.1	E5AZ 90S-4	1400	81.4	81.3	78.8	0.75	2.6	5.2	7.5	3	3.2	0.0028	13.1
1.5	E5AZ 90L-4	1415	82.8	82.5	80	0.74	3.5	5.3	10.1	3.1	3.3	0.0038	15.8
2.2	E5AZ 100LA-4	1435	84.3	83.9	81.5	0.72	5.2	6	14.7	3.4	3.7	0.0061	21.2
3	E5AZ 100LB-4	1440	85.5	85.3	85	0.72	7	7.5	20	3.5	4.1	0.0081	25
4	E5AZ 112M-4	1440	86.6	86.4	86.2	0.75	8.8	7.3	26.5	3	3.3	0.0122	30
5.5	E5AZ 132S-4	1455	87.7	87.5	85.8	0.8	11.3	7.7	36	3.3	4	0.0276	46
7.5	E5AZ 132M-4	1455	88.7	88.6	87.3	0.8	15.2	8	49	3.4	3.8	0.0350	58
11	E5AZ 160M-4	1465	89.8	89.6	87.1	0.78	22.5	7.4	72	3.4	3.8	0.0613	78
15	E5AZ 160L-4	1465	90.6	90.5	89.9	0.83	28.5	7.9	98	3.3	3.3	0.0879	101
1.1	E7AZ 90LR-4	1400	81.4	81.3	78.8	0.75	2.6	5.2	7.5	3	3.2	0.0028	32
1.5	E7AZ 90L-4	1415	82.8	82.5	80	0.74	3.5	5.3	10.1	3.1	3.3	0.0038	34
2.2	E7AZ 100LA-4	1435	84.3	83.9	81.5	0.72	5.2	6	14.7	3.4	3.7	0.0061	39
3	E7AZ 100LB-4	1440	85.5	85.3	85	0.72	7	7.5	20	3.5	4.1	0.0081	43
4	E7AZ 112M-4	1440	86.6	86.4	86.2	0.75	8.8	7.3	26.5	3	3.3	0.0122	52
5.5	E7AZ 132S-4	1455	87.7	87.5	85.8	0.8	11.3	7.7	36	3.3	4	0.0276	80
7.5	E7AZ 132M-4	1455	88.7	88.6	87.3	0.8	15.2	8	49	3.4	3.8	0.0350	86
11	E7AZ 160M-4	1465	89.8	89.6	87.1	0.78	22.5	7.4	72	3.4	3.8	0.0613	135
15	E7AZ 160L-4	1465	90.6	90.5	89.9	0.83	28.5	7.9	98	3.3	3.3	0.0879	155
18.5	E7AZ 180M-4	1460	91.2	91.6	90	0.83	35	7.3	121	2.9	3	0.1262	185
22	E7AZ 180L-4	1460	91.6	92	91	0.84	41	7.3	144	2.9	3	0.1515	193
30	E7AZ 200L-4	1470	92.3	92.4	91.4	0.84	55.8	7.6	195	3.3	3.3	0.2430	270
37	E7AZ 225S-4	1475	92.7	92.7	92.2	0.85	67.5	7	240	2.8	2.9	0.3825	340
45	E7AZ 225M-4	1475	93.1	93.1	92.9	0.83	84	6.9	291	3.3	3.3	0.4623	363
55	E7AZ 250M-4	1480	93.5	93.5	93	0.86	98.5	7.8	355	2.8	3	0.7180	481
75	E7AZ 280S-4	1485	94	93.6	93	0.82	140	7.5	482	2.4	2.8	1.1864	620
90	E7AZ 280M-4	1485	94.2	94	93.6	0.84	164	6.8	579	2.1	2.5	1.4240	680
110	E7AZ 315S-4	1485	94.5	93.7	93.1	0.84	200	6	707	1.9	2.2	2.5126	950
132	E7AZ 315M-4	1485	94.7	94.8	94.3	0.84	239	6.7	849	2	2.2	3.0988	1050
160	E7AZ 315LA-4	1490	95.8	95.4	94.9	0.83	290	7.2	1026	2	2.3	3.6851	1230
200	E7AZ 315LXB-4	1490	95.1	95	94.6	0.81	370	7.1	1282	2	2.3	4.4387	1300

Tablica 2.9. / Table 2.9. / Tabelle 2.9.

2p=6 IE2			1000 min ⁻¹				400V / 50Hz				B3		
P (kW)	Motor type	n (min ⁻¹)	η 100% (%)	η 75% (%)	η 50% (%)	cos φ	I _n (A)	$\frac{I_k}{I_n}$	M _n (Nm)	$\frac{M_k}{M_n}$	$\frac{M_{max}}{M_n}$	J (kgm ²)	m (kg)
0.12	E5AZ 63B-6	870	50.6	46.1	38.2	0.57	0.6	2.1	1.3	2.2	2.2	0.0003	4.2
0.18	E5AZ 71A-6	910	56.6	53.2	47.1	0.66	0.75	2.5	1.9	1.8	2.1	0.0005	5.5
0.25	E5AZ 71B-6	900	61.6	61.1	55.2	0.68	0.86	2.9	2.7	1.9	2.1	0.0010	5.7
0.37	E5AZ 80A-6	920	67.6	67.1	60.5	0.7	1.12	3.3	3.8	1.7	2.1	0.0018	7.8
0.55	E5AZ 80B-6	920	73.1	74.2	70.3	0.72	1.5	4	5.7	2.2	2.3	0.0023	10.5
0.75	E5AZ 90S-6	930	75.9	77.1	75.5	0.65	2.1	4.1	7.7	2.2	2.7	0.0028	13
1.1	E5AZ 90L-6	915	78.1	79	77.8	0.7	2.9	3.9	11.5	2.2	2.5	0.0038	16
1.5	E5AZ 100L-6	935	79.8	80	77.5	0.71	3.8	4.8	15.3	2.4	2.8	0.0104	20.5
2.2	E5AZ 112M-6	935	81.8	82.5	80.9	0.71	5.45	4.6	22.5	2.3	2.5	0.0148	25
3	E5AZ 132S-6	965	85.6	85.5	84	0.67	7.5	5.6	30	2.8	3.1	0.0315	41
4	E5AZ 132MA-6	965	84.6	84.1	81.6	0.65	10.4	6	40	3.1	3.4	0.0378	48
5.5	E5AZ 132MB-6	955	86	85.9	84.9	0.73	12.6	6	55	2.7	2.9	0.0453	53
7.5	E5AZ 160M-6	970	87.2	85.8	83.8	0.76	16.3	7.7	74	3.1	3.5	0.0925	94
11	E5AZ 160L-6	970	88.7	88.5	86.7	0.77	23.2	8	109	3.2	3.6	0.1261	110
0.75	E7AZ 90LR-6	930	75.9	77.1	75.5	0.65	2.1	4.1	7.7	2.2	2.7	0.0028	32
1.1	E7AZ 90L-6	915	78.1	79	77.8	0.7	2.9	3.9	11.5	2.2	2.5	0.0038	34
1.5	E7AZ 100L-6	935	79.8	80	77.5	0.71	3.8	4.8	15.3	2.4	2.8	0.0104	39
2.2	E7AZ 112M-6	935	81.8	82.5	80.9	0.71	5.45	4.6	22.5	2.3	2.5	0.0148	48
3	E7AZ 132S-6	965	85.6	85.5	84	0.67	7.5	5.6	30	2.8	3.1	0.0315	74
4	E7AZ 132MA-6	965	84.6	84.1	81.6	0.65	10.4	6	40	3.1	3.4	0.0378	79
5.5	E7AZ 132MB-6	955	86	85.9	84.9	0.73	12.6	6	55	2.7	2.9	0.0453	85
7.5	E7AZ 160M-6	970	87.2	85.8	83.8	0.76	16.3	7.7	74	3.1	3.5	0.0925	140
11	E7AZ 160L-6	970	88.7	88.5	86.7	0.77	23.2	8	109	3.2	3.6	0.1261	154
15	E7AZ 180L-6	975	89.7	90	89.6	0.81	29.5	8.1	147	2.7	3.8	0.1909	202
18.5	E7AZ 200LA-6	980	91.7	91.7	91.0	0.79	36.5	7.7	180	2.4	3.4	0.3615	287
22	E7AZ 200LB-6	980	92.2	92.2	92.0	0.78	44	8.1	214	2.6	3.8	0.4096	280
30	E7AZ 225M-6	980	91.7	91.7	91	0.8	59	6.9	292	3	3.1	0.7262	370
37	E7AZ 250M-6	985	92.2	92.2	91	0.78	74	7	470	3.1	3.4	1.0004	395
45	E7AZ 280S-6	985	92.7	92.7	92.3	0.78	89.5	6	436	2.8	3	1.4679	610
55	E7AZ 280M-6	985	93.1	92.6	92	0.77	110	6	533	2.8	3	1.7610	645
75	E7AZ 315S-6	990	94.6	94.2	93.6	0.82	139	7.6	723	2.6	2.6	4.4698	960
90	E7AZ 315M-6	990	94.9	94.4	93.8	0.83	165	7.0	868	2.4	2.4	5.5127	1035
110	E7AZ 315LA-6	995	95.1	94.6	94	0.79	211	7.3	1056	2.5	2.5	6.7047	1250
132	E7AZ 315LXB-6	995	95.4	94.6	94	0.79	252	7.2	1267	2.2	2.2	8.1946	1300

Tablica 2.10. / Table 2.10. / Tabelle 2.10.

2p=8 IE2			750 min ⁻¹				400V / 50Hz				B3		
P (kW)	Motor type	n (min ⁻¹)	η 100% (%)	η 75% (%)	η 50% (%)	cos φ	I _n (A)	$\frac{I_k}{I_n}$	M _n (Nm)	$\frac{M_k}{M_n}$	$\frac{M_{max}}{M_n}$	J (kgm ²)	m (kg)
0.09	E5AZ 71A-8	690	44.7	41	32	0.58	0.5	2.2	1.2	1.9	2.2	0.0007	4.7
0.12	E5AZ 71B-8	690	50.7	49	40	0.56	0.6	2.4	1.7	2	2.3	0.0010	5.2
0.18	E5AZ 80A-8	690	45.9	45	40	0.66	0.8	2.7	2.5	1.8	2.3	0.0018	7.7
0.25	E5AZ 80B-8	680	50.6	48.5	42	0.68	1	2.5	3.5	1.5	1.8	0.0022	8.9
0.37	E5AZ 90S-8	680	56.1	52.3	42.8	0.56	1.7	2.2	5.2	1.6	1.8	0.0028	11.4
0.55	E5AZ 90L-8	680	61.7	60.5	55.2	0.55	2.3	2.7	7.7	2	2.1	0.0031	13.7
0.75	E5AZ 100LA-8	700	66.2	65	62.5	0.64	2.55	3.1	10.2	1.6	2	0.0078	17
1.1	E5AZ 100LB-8	700	70.8	69.3	64.6	0.64	3.5	3.7	15	2.2	2.4	0.0104	20.5
1.5	E5AZ 112M-8	700	74.1	70.5	65.1	0.66	4.4	4	20.5	1.9	2.2	0.0148	24.7
2.2	E5AZ 132S-8	690	77.6	75	73.6	0.75	5.4	3.9	30.4	1.9	2.1	0.0262	39
3	E5AZ 132M-8	690	80	78.6	78.4	0.76	7.1	4.2	41.5	2.1	2.4	0.0365	48
4	E5AZ 160MA-8	715	84.8	84.7	84.6	0.74	9.2	5.1	53.4	2	2.6	0.0791	76
5.5	E5AZ 160MB-8	715	83.8	83.1	81.7	0.75	12.5	5.1	73.5	2	2.7	0.1044	84
7.5	E5AZ 160L-8	720	85.3	85	84.1	0.78	16.2	5	99.5	2	2.6	0.1423	100
0.37	E7AZ 90LR-8	680	56.1	52.3	42.8	0.56	1.7	2.2	5.2	1.6	1.8	0.0028	30
0.55	E7AZ 90L-8	680	61.7	60.5	55.2	0.55	2.3	2.7	7.7	2	2.1	0.0031	32.5
0.75	E7AZ 100LA-8	700	66.2	65	62.5	0.64	2.55	3.1	10.2	1.6	2	0.0078	36
1.1	E7AZ 100LB-8	700	70.8	69.3	64.6	0.64	3.5	3.7	15	2.2	2.4	0.0104	39
1.5	E7AZ 112M-8	700	74.1	70.5	65.1	0.66	4.4	4	20.5	1.9	2.2	0.0148	48
2.2	E7AZ 132S-8	690	77.6	75	73.6	0.75	5.4	3.9	30.4	1.9	2.1	0.0262	65
3	E7AZ 132M-8	690	80	78.6	78.4	0.76	7.1	4.2	41.5	2.1	2.4	0.0365	72
4	E7AZ 160MA-8	715	84.8	84.7	84.6	0.74	9.2	5.1	53.4	2	2.6	0.0791	118
5.5	E7AZ 160MB-8	715	83.8	83.1	81.7	0.75	12.5	5.1	73.5	2	2.7	0.1044	141
7.5	E7AZ 160L-8	720	85.3	85	84.1	0.78	16.2	5	99.5	2	2.6	0.1423	160
11	E7AZ 180L-8	725	88.6	88.6	87.1	0.77	23	6	145	2.2	2.8	0.2371	200
15	E7AZ 200L-8	730	89.6	89.6	85.3	0.74	32.5	5.9	196	2.1	2.8	0.4289	275
18.5	E7AZ 225S-8	735	90.1	89.6	87.8	0.71	41	7.4	242	2.5	3.6	0.6040	325
22	E7AZ 225M-8	735	90.6	91	90.6	0.75	46	7.3	286	2.2	2.9	0.7297	370
30	E7AZ 250M-8	735	91.3	91.3	90.6	0.76	62	6.7	390	2	2.5	1.2449	460
37	E7AZ 280S-8	735	91.8	91.8	91	0.78	74	6.1	481	1.9	2.4	1.9663	625
45	E7AZ 280M-8	740	92.2	91.8	91.1	0.74	94	6.9	581	2.2	2.6	2.3594	660
55	E7AZ 315S-8	745	92.5	91.5	90.5	0.78	109	8.9	705	2	2.4	4.5082	930
75	E7AZ 315M-8	745	93.1	92.8	91.6	0.83	140	9.2	961	2.1	2.5	5.5602	1090
90	E7AZ 315LA-8	745	93.4	93.1	91.7	0.8	173	9.3	1154	2.1	2.5	6.7604	1170
110	E7AZ 315LB-8	745	93.7	93.5	92	0.8	211	9.3	1410	2.1	2.5	8.2627	1290

2.1.3. IE3 trofazni kavezni asinkroni motori – PREMIUM

IE3

Zakonski propisana minimalna učinkovitost IE3 mora biti zadovoljena za motore snaga od 7,5 kW do 375 kW od 01.01.2015, a za raspon snaga od 0,75 kW do 375 kW od 01.01.2017. Alternativno, IE2 motori se mogu koristiti s frekvencijskim pretvaračem. Koncept održivog razvoja je potican kroz prilagodbu racionalnog korištenja energije u praksi.

Implementacija mjerenja energetske učinkovitosti u industriji, javnim službama i domaćinstvima donosi golemu uštedu financijski i u potrošnji energije, istovremeno smanjujući emisiju štetnih tvari u okolinu.

Danas, odgovorno ponašanje s energijom postaje imperativ za svakog proizvođača, distributera ili potrošača.

KONČAR-MES je u svom proizvodnom programu konstruirao motore visoke učinkovitosti IE3 koristeći optimizirane aktivne komponente serije 5 i 7. Neki od IE3 motora odgovaraju dimenzijama IE2 motora, a neki ne (povećana IEC veličina). Mehaničke dimenzije motora ostaju jednake kao i standardne. Veličina motora je važna značajka jer se mora prilagoditi mehaničkoj konstrukciji uređaja gdje se taj motor ugrađuje.

Karakteristike Premium učinkovitosti motora nudi prednosti kao što su:

- Viša učinkovitost znači manji štetan utjecaj na okoliš
- Kratki period povrata troškova cijene motora kroz manje troškove energije
- Daleko veće uštede tijekom kontinuiranog rada
- Povećavanje pouzdanosti zbog manjeg zagrijavanja motora/namota (veći aktivni dio motora s visokim magnetskim karakteristikama)
- Tiši rad motora

2.1.3. IE3 Three-phase squirrel cage induction motors – PREMIUM

The legally specified minimum efficiency IE3 must be maintained for power ratings from 7.5 kW to 375 kW from 1.1.2015 and for power ratings from 0.75 kW up to 375 kW from 1.1.2017. Alternatively, an IE2 motor can be used with a frequency converter.

Concept of sustainable development is encouraged through adoption of rational energy management practice. Implementation of energy effectiveness measurements in industry, public services and in households brings enormous savings in energy consumption and in financial funds, and at same time reduces emission of harmful substances in the environment.

Nowadays, responsible behaviour with energy is becoming imperative for each manufacturer, distributor and consumer.

KONČAR-MES, however, has in its production program designed motors or may offer high efficiency motors in class IE3 in short period of time by using of optimised active parts of 5 and 7 series. Some of the IE3 motors fit in the same IEC housing as the IE2 motors but some not (higher IEC size). The mechanical dimensions to the motors remain the same as standard. The size of motor is important aspect of motors and it need to adapt the mechanical design of the machine.

Process performance premium efficiency motors offer enhanced operating performance for the end user like:

- *Higher efficiency means higher energy effectiveness and less of harmful influence on environment.*
- *Short period of time for refunding motor price difference through smaller energy costs.*
- *Far higher savings during continuous duty cycles*
- *Increasing of reliability because of lower motor/winding heating (bigger active motor part with high magnetic characteristics)*
- *Quiet motor operation and low noise level*

2.1.3. IE3 Dreiphasenasynchronmotoren mit Käfigläufer – PREMIUM

Rechtlich spezifizierte Mindesteffizienz IE3 muss für die Motoren der Leistungen von 7.5 bis 375 kW seit dem 01.01.2015 und für den Leistungsbereich von 0.75kW bis 375kW ab den 01.01.2017 erreicht werden. Alternativ, die IE2 Motoren können mit dem Frequenzumrichter eingesetzt sein. Das Konzept haltbarer Entwicklung ist durch die Anpassung auf rationelle Energieausnutzung in Praxis gefordert. Die Einführung der Messung energetischer Effizienz in der Industrie, öffentlichen Diensten und Haushalten bringt enorme Einsparung und gleichzeitig reduziert die Schadstoffemission in der Umwelt. Verantwortlicher Umgang mit der Energie entsteht heute als Imperativ für jeden Hersteller, Distributeur oder Verbraucher. KONČAR-MES hat in seinem Produktionsprogramm die Motoren der PREMIUM Effizienz IE3 mittels optimierten Aktivteilen der Typenreihen 5 und 7. Konstruiert Einige von IE3 Motoren entsprechen in Dimensionen der IE2 Motoren jedoch einige nicht (vergrößerte IEC Baugröße). Die mechanische Dimensionen der Motoren, bleiben gleich wie standardmässige. Die Motorgröße ist eine bedeutende Eigenschaft, weil die muss mechanischer Konstruktion des Gerätes in welches man den Motor einbaut, angepasst werden.

Die Eigenschaften der Premiumeffizienz bedeuten eigentlich die Vorteile wie:

- höhere Effizienz bedeutet wenig schädlicher Umwelteinwirkung
- kurze Zeitperiode der Motorkaufpreiswiedererstattung durch geringere Energiekosten
- weit höhere Einsparungen während kontinuierliches Betriebes
- die Verlässlichkeitserhöhung wegen weniger Motor- und Wicklungserwärmung (größerer Aktivteil des Motors mit hohen magnetischen Eigenschaften)
- leisere Motorarbeit

Ovo se prenosi u visoku pouzdanost, lakše održavanje i dulji životni vijek – faktore koji smanjuju ukupne troškove.

Motori s premium učinkovitosti su posebno prikladni za industrijsku i OEM primjenu. Idealni su sve primjene koje zahtijevaju učinkovitos, pouzdanost, posebno pod teškim uvjetima rada.

- Stupanj korisnosti IE3 ima 15-20% manje gubitke nego IE2.
- U industriji se oko 40-50% energije koristi za pogon motora.
- Prosječna podjela troškova u životnom vijeku standardnog motora je:
- održavanje – 0,3%
- troškovi nabave – 1,7%
- energija – 98%

This translates into higher reliability, easier maintenance, and a longer life cycle –factors which reduce the overall cost of ownership.

Process performance premium efficiency motors are particularly suitable for industrial and OEM use. They are ideal for all applications demanding efficiency and reliability, especially under challenging conditions.

- *Efficiency class IE3 has 15-20% lower losses than IE2.*
- *In industry is approximately 40-50% of energy used in motors.*
- *Average life cycle costing of a standard electrical motor: maintenance – 0,3% ; purchasing – 1,7%; energy – 98%.*

Dies alles transferiert sich in hoher Verlässlichkeit, leichterem Wartung und längerem Lebensdauer – alle Faktoren, welche die Gesamtkosten reduzieren.

Die Motoren mit der Premiumeffizienz sind besonders für industrielle OEM Anwendungen geeignet. Die sind ideal für alle Anwendungen, welche Effizienz und Verlässlich besonders unter schweren Arbeitsbedingungen verlangen.

- Die IE3 Effizienzklasse hat 15-20 % weniger Verluste als IE2.
- In der Industrie verbraucht man ca. 40-50 % an der Energie für den Motorenantrieb.
- Die durchschnittliche Kostenaufteilung während der Lebensdauer des Motors beträgt: Wartung – 0,3%; Einkauf -1,7%; Energieverbrauch -98%.

Slika 2.1. / Picture 2.1. / Bild 2.1.

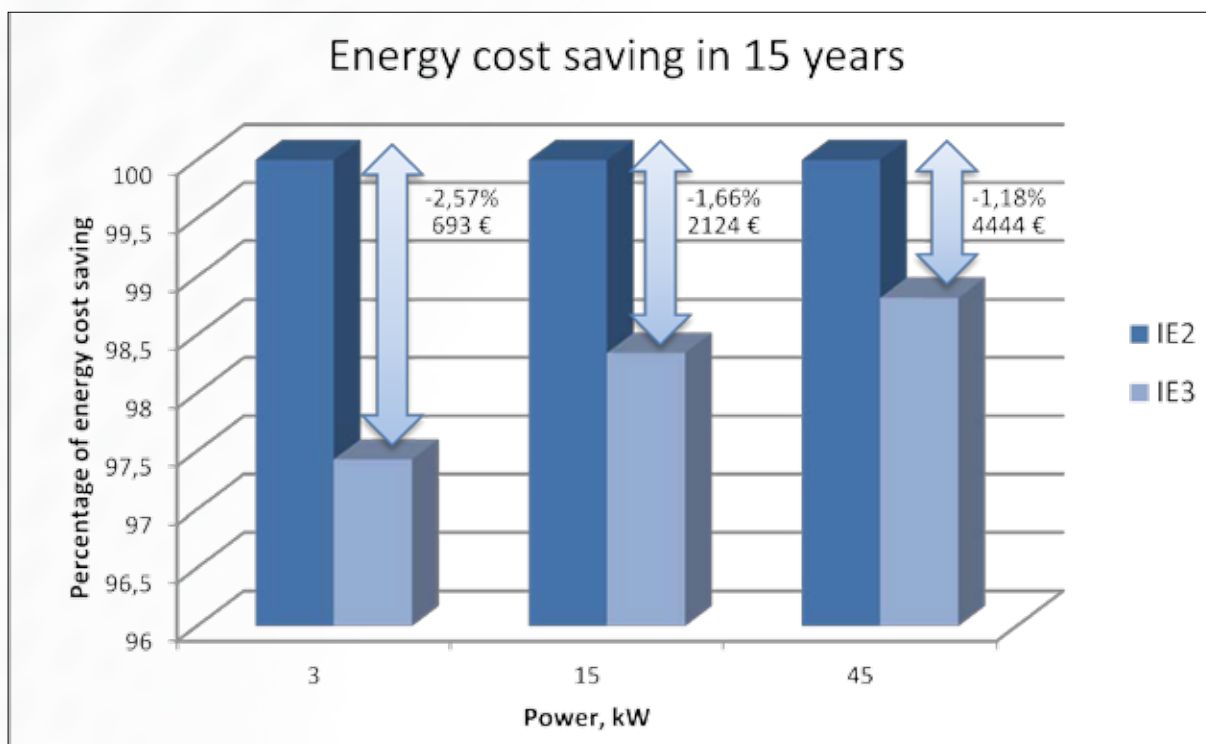

Slika 2.1.: Prikaz uštede za 4-polne motore snaga 3, 15 i 45 kW klasa korisnosti IE2 i IE3 koji rade 3500 sati godišnje tijekom 15 godina uz prosječnu cijenu koštanja kWh u Europi 0,15 €/h

Picture 2.1.: Display of savings for 4 pole motors with powers 3, 15 and 45 kW in efficiency IE2 and IE3 which are working 3500 hours/year during 15 years. Average cost of kWh in Europe 0,15 € was taken into calculation.

Das Bild 2.1.: Einsparungsdarstellung für 4-polige Motoren der Leistungen 3,15 und 45 kW der Effizienzklassen IE2 und IE3, welchen 3500 Stunden pro Jahr während 15 Jahren im Betrieb sind. Dabei sind die Durchschnittskosten für 1 kWh in Europa mit 0,15 € in der Rechnung eingenommen.

Tablica 2.11. / Table 2.11. / Tabelle 2.11.

Standardna izvedba	Standard design	Standardausführung
serije i veličine:	motor series and frame sizes:	Baureihen und Baugrößen
5AZ 56-160 u siluminom, tlačno lijevanom orebrenom kućištu s odlivenim nogama,	5AZ 56 – 160 in ribbed die casted aluminum alloy frame, with casted feet,	5AZ 56 – 160 im gerippten Alu-Druckgussgehäuse mit gegossenen Füßen,
7AZ 90-315 u orebrenom kućištu od sivog lijeva s montažnim nogama	7AZ 90 – 315 in ribbed cast iron frame with dismountable feet	7AZ 90 – 315 im gerippten Graugussgehäuse mit angeschraubten Füßen
oblici ugradnje :	mounting arrangements:	Bauformen:
IM B3, B5, B35, B14 i B34 (dva posljednja do uključivo veličine 132)	IM B3, B5, B35, B14 and B34 (last two available up to frame size 132)	IM B3, B5, B35, B14 und B34 (die zwei letzten bis einschließlich der Bgr.132)
priključni ormarić:	Terminal box:	Klemmenkasten:
metalni, gledano sa strane pogonskog vratila u oblicima IM B3, B35 i B34 smješten gore uvodnice i čepovi sa „M“ navojem prema tehničkim razjašnjenjima	metal, viewed from drive end side in mounting arrangements IMB3, B35 and B34 situated on top cable glands and cable plugs with „M“ thread according to technical explanations	aus Metall, von der Antriebswellenseite betrachtet in Bauformen IMB3, B35 und B34 oben aufgestellt, Kabelverschraubungen und Stopfen mit metrischem Gewinde M nach technischen Erläuterungen
raspon snaga:	power range:	leistungsbereich:
0.09 – 200 kW	0.06 – 200 kW	0.06 – 200 kW
Vrsta pogona:	Duty type:	Betriebsart:
S1; (za okolinu –20°C do +40°C i postav do 1000 m nm.)	S1 (for ambient from -20°C to +40°C and altitude up to 1000 m above sea level)	S1 (für die Umgebung von -20°C bis +40°C und die Aufstellung bis 1000m über den Meeresspiegel)
napon i frekvencija:	voltage and frequency:	spannung u.frequenz:
230/400 V ± 10% Δ/Y (do 2,2 kW), 400/690V ± 10% Δ/Y (od 3 kW) i 50 Hz	230/400 V ± 10% Δ/Y (to 2,2 kW), 400/690V ± 10% Δ/Y (from 3 kW) i 50 Hz	230/400 V ± 10% /Y (bis 2,2 kW), 400/690V ± 10% /Y (ab 3 kW) i 50 Hz
iskoristivost:	efficiency:	Wirkungsgrad:
u klasi IE2 prema IEC 60034-30 mjerenje prema IEC 60034-2-1	in class IE2 according to IEC 60034-30 agreement measurement according to IEC 60034-2-1	in Wirkungsgradklasse IE2 nach der IEC 60034- 30 Vereinbarung gemessen nach IEC 60034-2-1
Broj polova:	number of poles:	polpaarzahl:
jednobrzijski motori: 2, 4, 6 i 8 standardno	single-speed motors: 2, 4, 6 and 8 as standard	eintourige Motoren: 2, 4, 6 und 8 standardmäßig
stupanj zaštite:	protection index:	schutzart:
IP55	IP55	IP55
Klasa izolacije:	insulation class:	isolationsklasse:
F (zagrijavanje u B)	F (rise in B)	F (Erwärmung in B)
ton boje:	colour tone:	farbton:
RAL 5010	RAL 5010	RAL 5010

Tablica 2.12. / Table 2.12. / Tabelle 2.12.

2p=2 IE3			3000 min ⁻¹				400V / 50Hz				B3		
P (kW)	Motor type	n (min ⁻¹)	η 100% (%)	η 75% (%)	η 50% (%)	cos φ	I _n (A)	$\frac{I_k}{I_n}$	M _n (Nm)	$\frac{M_k}{M_n}$	$\frac{M_{max}}{M_n}$	J (kgm ²)	m (kg)
0.18	H5AZ 63A-2	2810	65.9	61.5	55.4	0.75	0.52	4.3	0.6	3.3	3.3	0.00015	3.8
0.25	H5AZ 63B-2	2840	69.7	64.9	58.6	0.71	0.72	5.1	0.8	3.3	3.8	0.00019	4.2
0.37	H5AZ 71A-2	2780	73.8	72.3	68.1	0.74	0.97	4.1	1.3	2.5	2.8	0.0002675	5
0.55	H5AZ 71B-2	2790	77.8	77.5	73.7	0.72	1.4	4.6	1.9	3.1	3.3	0.0003864	5.8
0.75	H5AZ 80A-2	2840	80.7	79	76	0.79	1.69	5.4	2.5	2.9	3.2	0.0006	9
1.1	H5AZ 80B-2	2840	82.7	82.7	81.9	0.8	2.4	5.8	3.7	2.9	3.2	0.0008	9.5
1.5	H5AZ 90S-2	2850	84.2	84.1	83.7	0.79	3.25	5.7	5	2.7	3.5	0.0014	12.5
2.2	H5AZ 90L-2	2875	85.9	86.6	85.6	0.8	4.6	6.8	7.3	3.6	4.1	0.0027	15
3	H5AZ 100L-2	2910	87.1	87	86.5	0.81	6.1	8	9.8	3.9	4.3	0.0040	23
4	H5AZ 112M-2	2925	88.1	87.4	87.4	0.79	8.25	9	13.1	3.3	4.4	0.0063	28.5
5.5	H5AZ 132SA-2	2935	89.2	88.7	87.6	0.85	10.4	9.8	17.9	3.6	4.4	0.0165	52
7.5	H5AZ 132MR-2	2940	90.1	88.8	87.8	0.86	13.9	10.0	24.4	3.6	4.4	0.0198	55
11	H5AZ 160MA-2	2950	91.2	90.8	90	0.89	19.5	10	35.6	3.1	4.9	0.0448	95
15	H5AZ 160MB-2	2950	91.9	91.6	90.7	0.89	26.4	9.8	48.6	3.3	4.9	0.0535	110
18.5	H7AZ 160L-2	2950	92.4	92.1	90.5	0.9	32	10.4	60	3.8	4.4	0.0622	125
1.5	H7AZ 90LR-2	2850	84.2	84.1	83.7	0.79	3.25	5.7	5	2.7	3.5	0.0014	29
2.2	H7AZ 90L-2	2875	85.9	86.6	85.6	0.8	4.6	6.8	7.3	3.6	4.1	0.0027	31
3	H7AZ 100L-2	2910	87.1	87	86.5	0.81	6.1	8	9.8	3.9	4.3	0.0040	47
4	H7AZ 112M-2	2925	88.1	87.4	87.4	0.79	8.25	9	13.1	3.3	4.4	0.0063	53
5.5	H7AZ 132SA-2	2935	89.2	88.7	87.6	0.85	10.4	9.8	17.9	3.6	4.4	0.0165	80
7.5	H7AZ 132SB-2	2940	90.1	88.8	87.8	0.86	13.9	10.0	24.4	3.6	4.4	0.0198	85
11	H7AZ 160MA-2	2950	91.2	90.8	90	0.89	19.5	10	35.6	3.1	4.9	0.0448	138
15	H7AZ 160MB-2	2950	91.9	91.6	90.7	0.89	26.4	9.8	48.6	3.3	4.9	0.0535	150
18.5	H7AZ 160L-2	2950	92.4	92.1	90.5	0.9	32	10.4	60	3.8	4.4	0.0622	163
22	H7AZ 180M-2	2965	92.7	92	91	0.86	39.5	10.2	71	2.6	3.4	0.0945	205
30	H7AZ 200LA-2	2965	93.3	92.8	92	0.89	52	10.1	97	2.7	2.9	0.1551	270
37	H7AZ 200LB-2	2965	93.7	92.8	92.1	0.89	64	9.6	119	2.9	3.1	0.1861	281
45	H7AZ 225M-2	2970	94	93.4	92.2	0.88	78.5	9.6	145	3	3.6	0.2602	365
55	H7AZ 250M-2	2975	94.3	93.7	93	0.89	94.5	9.9	177	3.1	3.2	0.4255	430
75	H7AZ 280S-2	2980	94.7	93.9	93.3	0.85	134.5	8	240	3	3.3	0.6105	564
90	H7AZ 280M-2	2985	95	94.3	93.4	0.85	161	8	288	2.9	3.2	0.7326	640
110	H7AZ 315S-2	2985	95.2	94.5	93.5	0.9	185	9.2	352	2.2	2.6	1.4432	940
132	H7AZ 315M-2	2985	95.4	94.7	93.6	0.91	219	8.4	422	1.9	2.4	1.7319	1015
160	H7AZ 315LA-2	2985	95.6	95.2	94	0.9	268	11.5	512	2.4	2.6	2.0992	1075
200	H7AZ 315LXB-2	2985	95.8	95.4	94.7	0.91	330	9.8	640	2.1	2.5	2.5191	1220

Tablica 2.13. / Table 2.13. / Tabelle 2.13.

2p=4 IE3			1500 min ⁻¹				400V / 50Hz				B3		
P (kW)	Motor type	n (min ⁻¹)	η 100% (%)	η 75% (%)	η 50% (%)	cos φ	I _n (A)	$\frac{I_k}{I_n}$	M _n (Nm)	$\frac{M_k}{M_n}$	$\frac{M_{max}}{M_n}$	J (kgm ²)	m (kg)
0.12	H5AZ 63A-4	1385	64.8	63.1	58.3	0.66	0.4	3.8	0.8	3.1	3	0.0003	4.2
0.18	H5AZ 63B-4	1385	69.9	68.5	61.1	0.61	0.6	3.8	1.2	3.4	3.2	0.0003	4.2
0.25	H5AZ 71A-4	1405	73.5	73.9	71.3	0.71	0.69	4.2	1.7	2.4	2.6	0.0006	5.8
0.37	H5AZ 71B-4	1400	77.3	76.0	71.0	0.71	0.97	4.5	2.5	2.5	2.7	0.0007932	6.8
0.55	H5AZ 80A-4	1400	80.8	82.9	81.3	0.75	1.3	4.7	3.7	2.3	2.6	0.0013	9.2
0.75	H5AZ 80B-4	1410	82.5	83	82	0.75	1.75	5	5.1	2.6	2.7	0.0016	11
1.1	H5AZ 90LR-4	1435	84.1	84.5	82.5	0.69	2.7	6.2	7.3	3.8	4	0.0036	15.3
1.5	H5AZ 90L-4	1435	85.3	85	83.5	0.72	3.5	5.9	10	3.5	3.8	0.0044	16.7
2.2	H5AZ 100LA-4	1445	86.7	86.3	86	0.76	4.8	7.1	14.5	3.5	3.8	0.0081	25
3	H5AZ 100LB-4	1460	87.7	87.6	87	0.79	6.2	5.8	19.6	2.4	3.2	0.0081	27
4	H5AZ 112MX-4	1455	88.6	88	87.5	0.78	8.3	7.8	26.3	3.9	4	0.0165	40
5.5	H5AZ 132MR-4	1460	89.6	88.8	88	0.79	11.2	9.3	36	4	4.9	0.0350	63
7.5	H5AZ 132M-4	1460	90.4	90.2	89.1	0.82	14.6	8.7	49.1	3.8	4.5	0.0423	66
11	H5AZ 160M-4	1470	91.4	90.8	89.8	0.82	21	8.9	71.5	3.8	3.8	0.0879	100
15	H5AZ 160L-4	1470	92.1	91	89	0.79	29.7	8	97.4	3.8	4.2	0.1032	112
1.1	H7AZ 90LR-4	1435	84.1	84.5	82.5	0.69	2.7	6.2	7.3	3.8	4	0.0036	30
1.5	H7AZ 90L-4	1435	85.3	85	83.5	0.72	3.5	5.9	10	3.5	3.8	0.0044	31
2.2	H7AZ 100LA-4	1445	86.7	86.3	86	0.76	4.8	7.1	14.5	3.5	3.8	0.0081	46
3	H7AZ 100LB-4	1460	87.7	87.6	87	0.79	6.2	5.8	19.6	2.4	3.2	0.0081	49
4	H7AZ 112M-4	1455	88.6	88	87.5	0.78	8.3	7.8	26.3	3.9	4	0.0165	52
5.5	H7AZ 132S-4	1460	89.6	88.8	88	0.79	11.2	8	36	3.5	4.3	0.0350	85
7.5	H7AZ 132MX-4	1460	90.4	90.2	89.1	0.82	14.6	8.7	49.1	3.8	4.5	0.0423	94
11	H7AZ 160M-4	1470	91.4	90.8	89.8	0.82	21	8.9	71.5	3.8	3.8	0.0879	157
15	H7AZ 160L-4	1470	92.1	91	89	0.79	29.7	8	97.4	3.8	4.2	0.1032	165
18.5	H7AZ 180M-4	1470	92.6	92	91.5	0.83	34.7	8.4	120	3.7	3.7	0.1703	215
22	H7AZ 180L-4	1470	93	92.5	91.8	0.83	41	9.4	143	3.9	3.9	0.1893	222
30	H7AZ 200L-4	1475	93.6	93.6	92.6	0.86	53.5	9.9	194	3.8	3.8	0.2916	290
37	H7AZ 225S-4	1480	93.9	93.8	92.6	0.83	68.5	9.0	239	4	4	0.4623	354
45	H7AZ 225M-4	1480	94.2	93.8	93.3	0.86	80	8.8	290	3.7	3.7	0.5420	382
55	H7AZ 250M-4	1480	94.6	94	93.6	0.88	95	9.8	355	3.9	4.2	0.8415	511
75	H7AZ 280S-4	1485	95	94.3	93.8	0.85	134	8.9	482	3.1	3.1	1.4240	680
90	H7AZ 280M-4	1485	95.2	94.5	94	0.83	164	9.6	579	3.3	3.3	1.5822	720
110	H7AZ 315S-4	1485	95.4	94.9	94.1	0.84	198	6.8	707	2	2.4	2.5874	1050
132	H7AZ 315M-4	1485	95.6	95.0	94.5	0.85	234	6.8	849	1.9	2.3	3.0578	1170
160	H7AZ 315LA-4	1490	95.8	95.4	94.9	0.83	290	7.2	1026	2	2.3	3.6851	1210
200	H7AZ 315LXB-4	1490	96	95.5	95	0.81	370	7.1	1282	2	2.3	4.4387	1300

Tablica 2.14. / Table 2.14. / Tabelle 2.14.

2p=6 IE3			1000 min ⁻¹				400V / 50Hz				B3		
P (kW)	Motor type	n (min ⁻¹)	η 100% (%)	η 75% (%)	η 50% (%)	cos φ	I _n (A)	$\frac{I_k}{I_n}$	M _n (Nm)	$\frac{M_k}{M_n}$	$\frac{M_{max}}{M_n}$	J (kgm ²)	m (kg)
0.12	H5AZ 63B-6	875	57.7	48.4	41.1	0.57	0.52	2.3	1.3	1.8	1.8	0.0004	4.8
0.18	H5AZ 71A-6	915	63.9	93.3	57.8	0.67	0.6	3.2	1.9	2	2.2	0.0007	5.4
0.25	H5AZ 71B-6	920	68.6	66.2	59.2	0.62	0.84	3.3	2.6	2.2	2.5	0.0083	6.1
0.37	H5AZ 80A-6	930	73.5	73.6	69.9	0.72	1	3.9	3.8	2	2.2	0.0022	8.6
0.55	H5AZ 80B-6	925	77.2	75.5	70.2	0.67	1.53	4.1	5.7	2.3	2.5	0.02435	10.3
0.75	H5AZ 90S-6	930	78.9	77.1	75.5	0.65	2.1	4.1	7.7	2.2	2.7	0.0028	13.5
1.1	H5AZ 90L-6	940	81	81.3	81	0.63	3.1	4.7	11.2	2.9	3.3	0.0044	19
1.5	H5AZ 100L-6	950	82.5	82	81	0.62	4.2	5.5	15.1	3.2	3.6	0.0130	24.0
2.2	H5AZ 112M-6	960	84.3	83	81.2	0.67	5.6	6.3	21.9	3.2	3.5	0.0215	34
3	H5AZ 132S-6	965	85.6	85.5	84	0.67	7.5	5.6	30	2.8	3.1	0.0315	41
4	H5AZ 132MA-6	960	86.8	87	86.5	0.76	8.7	5.9	40	2.4	2.7	0.0453	53
5.5	H5AZ 132MB-6	970	88	87.5	86	0.75	12	7.4	54	2.4	3.8	0.0516	58
7.5	H5AZ 160M-6	975	89.1	89.0	87.5	0.75	16	8.8	73.5	3.5	4.4	0.1262	110
11	H5AZ 160L-6	975	90.3	90.0	89	0.75	23.4	8.4	107.7	3.3	4.4	0.1514	123
0.75	H7AZ 90LR-6	930	78.9	77.1	75.5	0.65	2.1	4.1	7.7	2.1	2.8	0.0038	28
1.1	H7AZ 90L-6	940	81	81.3	81	0.63	3.1	4.7	11.2	2.9	3.3	0.0044	33
1.5	H7AZ 100L-6	950	82.5	82	81	0.62	4.2	5.5	15.1	3.2	3.6	0.0130	39
2.2	H7AZ 112M-6	960	84.3	83	81.2	0.67	5.6	6.3	21.9	3.2	3.5	0.0215	56
3	H7AZ 132S-6	965	85.6	85.5	84	0.67	7.5	5.6	30	2.8	3.1	0.0315	74
4	H7AZ 132MA-6	960	86.8	87	86.5	0.76	8.7	5.9	40	2.4	2.7	0.0453	90
5.5	H7AZ 132MB-6	970	88	87.5	86	0.75	12	7.4	54	2.4	3.8	0.0516	96
7.5	H7AZ 160M-6	975	89.1	89.0	87.5	0.75	16	8.8	73.5	3.5	4.4	0.1262	155
11	H7AZ 160L-6	975	90.3	90.0	89	0.75	23.4	8.4	107.7	3.3	4.4	0.1514	167
15	H7AZ 180L-6	980	91.2	89.1	87.9	0.72	33	9.5	146	3.6	5.1	0.2386	220
18.5	H7AZ 200LA-6	980	91.7	91.7	91.0	0.79	36.5	7.7	180	2.4	3.4	0.3615	287
22	H7AZ 200LB-6	980	92.2	92.2	92.0	0.78	44	8.1	214	2.6	3.8	0.4096	280
30	H7AZ 225M-6	980	92.9	92.5	92	0.78	59.5	7.4	292	3	3	0.7262	370
37	H7AZ 250M-6	985	93.3	93.1	93	0.8	71	7.3	359	3.5	3	1.1726	482
45	H7AZ 280S-6	985	93.7	92.8	92.2	0.75	92.4	6.5	436	3	2.5	1.4675	610
55	H7AZ 280M-6	990	94.1	93.2	92.5	0.74	114	6.6	531	3.5	2.7	1.7610	645
75	H7AZ 315S-6	990	94.6	94.2	93.6	0.82	139	7.6	723	2.6	2.6	4.4698	960
90	H7AZ 315M-6	990	94.9	94.4	93.8	0.83	165	7.0	868	2.4	2.4	5.5127	1035
110	H7AZ 315LA-6	995	95.1	94.6	94	0.79	211	7.3	1056	2.5	2.5	6.7047	1250
132	H7AZ 315LXB-6	995	95.4	94.6	94	0.79	252	7.2	1267	2.2	2.2	8.1946	1300

Tablica 2.15. / Table 2.15. / Tabelle 2.15.

2p=8 IE3			750 min ⁻¹				400V / 50Hz				B3		
P (kW)	Motor type	n (min ⁻¹)	η 100% (%)	η 75% (%)	η 50% (%)	cos φ	I _n (A)	$\frac{I_k}{I_n}$	M _n (Nm)	$\frac{M_k}{M_n}$	$\frac{M_{max}}{M_n}$	J (kgm ²)	m (kg)
0.09	H5AZ 71A-8	690	44.7	41	32	0.58	0.5	2.2	1.2	1.9	2.2	0.0007	4.7
0.12	H5AZ 71B-8	690	50.7	49	40	0.56	0.6	2.4	1.7	2	2.3	0.0010	5.2
0.18	H5AZ 80A-8	690	58.7	55.3	47.7	0.63	0.7	3	2.5	2	2.3	0.0018	7.8
0.25	H5AZ 80B-8	680	64.1	62.9	56.8	0.66	0.85	2.9	3.5	1.8	2	0.0022	8.9
0.37	H5AZ 90S-8	690	69.3	69.2	58.2	0.59	1.3	3.2	5.1	2.1	2.4	0.0028	13
0.55	H5AZ 90L-8	700	73	70.2	64.4	0.55	1.97	3.6	7.5	2.5	2.9	0.0038	15
0.75	H5AZ 100LA-8	705	75	74	70	0.55	2.6	3.8	10.2	2.7	2.9	0.0104	20.5
1.1	H5AZ 112MR-8	710	77.7	78	76	0.58	3.5	4.5	14.8	2.7	3.1	0.0189	34
1.5	H5AZ 112MX-8	715	79.7	79.4	76	0.6	4.5	4.5	20	2.4	2.9	0.0236	38
2.2	H5AZ 132S-8	715	81.9	81	78.8	0.68	5.7	5.1	29	2.8	3.4	0.0365	35
3	H5AZ 132M-8	710	83.5	83	80.6	0.66	7.8	5.1	40	2.8	3.2	0.0394	43
4	H5AZ 160MA-8	715	84.8	84.7	84.6	0.74	9.2	5.1	53	2	2.6	0.0791	65
5.5	H5AZ 160MB-8	725	86.2	86	83.9	0.67	13.7	5.8	72	2.5	3.4	0.1044	89
7.5	H5AZ 160L-8	720	87.3	87.3	86.4	0.77	16	5	99	1.9	2.5	0.1423	95
0.37	H7AZ 90LR-8	690	69.3	69.2	58.2	0.59	1.3	3.2	5.1	2.1	2.4	0.0028	19
0.55	H7AZ 90L-8	700	73	70.2	64.4	0.55	1.97	3.6	7.5	2.5	2.9	0.0038	23
0.75	H7AZ 100LA-8	705	75	74	70	0.55	2.6	3.8	10.2	2.7	2.9	0.0104	31
1.1	H7AZ 112MR-8	710	77.7	78	76	0.58	3.5	4.5	14.8	2.7	3.1	0.0189	50
1.5	H7AZ 112M-8	715	79.7	79.4	76	0.6	4.5	4.5	20	2.4	2.9	0.0236	57
2.2	H7AZ 132S-8	715	81.9	81	78.8	0.68	5.7	5.1	29	2.8	3.4	0.0365	72
3	H7AZ 132M-8	710	83.5	83	80.6	0.66	7.8	5.1	40	2.8	3.2	0.0394	75
4	H7AZ 160MA-8	715	84.8	84.7	84.6	0.74	9.2	5.1	53	2	2.6	0.0791	118
5.5	H7AZ 160MB-8	725	86.2	86	83.9	0.67	13.7	5.8	72	2.5	3.4	0.1044	140
7.5	H7AZ 160L-8	725	87.3	87.3	86	0.72	17.2	5.9	99	2.3	2.9	0.1423	156
11	H7AZ 180L-8	725	88.6	88.6	87.1	0.77	23	6	145	2.2	2.8	0.2371	200
15	H7AZ 200L-8	730	89.6	89.6	85.3	0.74	32.5	5.9	196	2.1	2.8	0.4289	285
18.5	H7AZ 225S-8	735	90.1	89.6	87.8	0.71	41	7.4	240	2.5	3.6	0.6040	325
22	H7AZ 225M-8	735	90.6	91	90.6	0.75	46	7.3	286	2.2	2.9	0.7297	370
30	H7AZ 250M-8	735	91.3	91.3	90.6	0.76	62	6.7	390	2	2.5	1.2449	480
37	H7AZ 280S-8	735	91.8	91.8	91	0.78	74	6.1	481	1.9	2.4	1.9663	630
45	H7AZ 280M-8	740	92.2	91.8	91.1	0.74	94	6.9	581	2.2	2.6	2.3594	700
55	H7AZ 315S-8	745	92.5	91.5	90.5	0.78	109	8.9	705	2	2.4	4.5082	920
75	H7AZ 315M-8	745	93.1	92.8	91.6	0.83	140	9.2	961	2.1	2.5	5.5602	1060
90	H7AZ 315LA-8	745	93.4	93.1	91.7	0.8	173	9.3	1154	2.1	2.5	6.7604	1100
110	H7AZ 315LB-8	745	93.7	93.5	92	0.8	211	9.3	1410	2.1	2.5	8.2627	1230

2.2. Višerbrzinski motori

KONČAR-MES proizvodi višerbrzinske trofazne zatvorene asinkrone motore u dvije ili više brzina i snaga u jednoj veličini.

Dvobrzinske motore smo podijelili u dvije grupe prema tipu namota:

- DAHLANDER – jedan namot s dva statorska polariteta što daje mogućnost promjene brzine motora u omjerima 2:1 mijenjajući samo način spajanja (4/2, 8/4, ...)
- DVA ODVOJENA NAMOTA ili DVOSTRUKI NAMOT – motor ima dva posebna namota na različitim polaritetima u jednom statoru. Svaki namot ima svoje karakteristike snage (6/4, 8/6, 12/4, ...)

Na zahtjev je moguće dobiti kombinaciju obje grupe navedene gore, kako bi se dobio trobrzinski ili četverbrzinski motor.

2.2. Multi-speed motors

We offer our three-phase squirrel cage multi speed induction motors in two or more outputs and speeds from a single frame. We divided two speed into two different winding types:

- *Tap wound- single winding with two stator winding polarities which gives the ability to change motor speeds at ratios of 2:1 by varying the connections (4/2, 8/4, ...)*
- *Two separate windings or dual wound- the motor has two distinctly different windings of different polarities within the same stator with each having its own power rating (6/4, 8/6, 12/4, ...)*

On request it is possible to have a combination of both the above systems and obtain a three or four speed motor.

2.2. Mehrtourige Motoren

KONČAR-MES proizvodi mehrtourige dreifazige Asynchronmotoren mit Käfigläufer, mit zwei oder mehr Drehzahlen und Leistungen in einer Baugröße. Die zweitourigen Motoren haben wir in zwei Gruppen nach der Wicklungsausführung aufgeteilt:

- als Dahlanderschaltung – eine Wicklung mit zwei Statorpolzahlen, was ermöglicht die Drehzahländerung des Motors in Verhältnissen 2:1 nur mittels der Schaltungsartänderung (4/2, 8/4..)
- als mit zwei getrennten Wicklungen – der Motor hat zwei eindeutig verschiedene Wicklungen von verschiedenen Polzahlen in einem Ständer. Jede Wicklung hat seine eigene Leistungscharakteristiken (6/4, 8/6, 12/4...)

Auf Anfrage ist es möglich eine Kombination der oben erwähnten Gruppen zu erzielen um einen dreitourigen oder viertourigen Motor zu bekommen.

Uglavnom postoje dvije glavne kategorije definirane prema zahtjevima za momentom u primjeni:

- KONSTANTNI MOMENT – Primjena s konstantnim momentom zahtjeva visoke početne momente prilikom pokretanja i konstantni moment u radu. Izlaz se povećava ili smanjuje proporcionalno s brzinom. Tipične primjene motora s konstantnim momentom su kompresori, strojevi za strojnu obradu, konvejeri, dizala...
- PROMJENJIVI MOMENT – ove primjene ne zahtijevaju visoki početni moment prilikom pokretanja. Moment se povećava ili smanjuje kao kvadrat povećanja ili smanjivanja brzine. Zahtjev za izlaznom snagom na manjoj brzini je oko ¼ onoga na punoj brzini. S druge strane, moment je cca 3 puta veći ako se brzina poveća 1,5 puta. Tipične primjene ovakvih motora su ventilatori i pumpe.

There are mainly two categories specified according to the torque requirements of applications;

- *CONSTANT TORQUE: Constant torque applications require high starting torque during startup and constant torque throughout the speed range. Output increases or decreases in proportion to speed. Typical constant torque applications are compressors, machine tools, conveyors and hoisting equipment.*
- *VARIABLE TORQUE: Variable torque applications do not require high starting torque during startup. Torque increases or decreases as the square of an increase and decrease in speed. Output power requirement at half speed is about one quarter of that at full speed. Otherwise it is about three times when the speed increases 1,5 times the full speed. Typical variable torque applications are fans and pumps.*

Meistens existieren zwei Hauptkategorien definiert nach Momentanforderungen in der Praxis;

- KONSTANTER MOMENT: die Anwendung mit konstantem Moment fordert hohe Momentwerte während des Anlaufs und konstanter Moment in Arbeit. Die Momentabgabe wächst oder verringert sich proportional mit der Drehzahl. Typische Anwendungsbeispiele der Motoren mit konstantem Moment sind Kompressoren, Werkzeugmaschinen, Förderbänder, Aufzüge usw.
- VARIABLER MOMENT: diese Anwendungen fordern keine hohen Anlaufmomente während des Anlaufs. Der Moment wächst oder verringert sich im quadratischen Verhältnis zur Drehzahl. Der Bedarf für die Leistungsabgabe auf kleinerer Drehzahl ist ca. ¼ deren auf hoher Drehzahl. Andererseits der Moment ist um etwa 3 Mal höher, wenn sich die Drehzahl um 1,5 Mal erhöht. Typische Anwendungsbeispiele solcher Motoren sind Ventilatoren und Pumpen.

Slika 2.2. / Picture 2.2. / Bild 2.2.

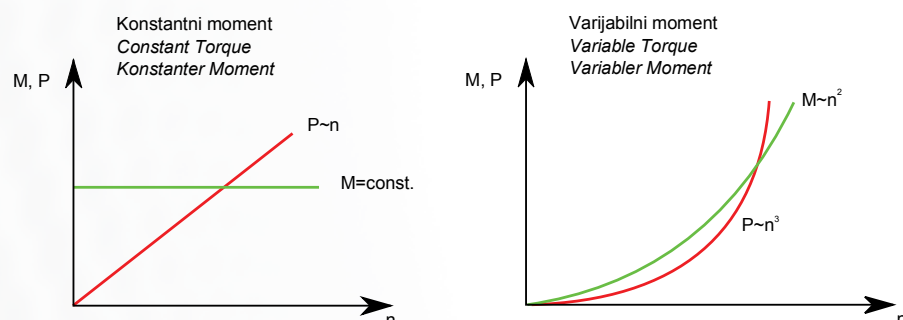

2.2.1. Sheme spajanja

Spajanje motora s konstantnim momentom je D/YY a s promjenjivim momentom je Y/YY za Dahlander spoj. Za motore s odvojenim namotom, spajanje je Y/Y za konstantni i promjenjivi moment. Dvobrzinski motori se pokreću iz niže brzine, a zatim se prebacuju na višu brzinu. Motori s Dahlander spojem su prikladni samo za direktno upuštanje. Na zahtjev, moguće je napraviti Y/D pokretanje. Veze na priključnoj pločici su prikazane u tablicama 2.10. i 2.11.:

2.2.1. Connection diagrams

The connection of constant torque is D/YY and variable torque is Y/YY for dahlander wound motors. For dual wound motors, connection is Y/Y for both constant and variable torque. Two speed motors must first be started at low speed and then switched over to higher speed. Dahlander connected motors are suitable for DOL starting only. On request Y/D starting is possible. Terminal connections are as follows in tables 2.10. and 2.11.:

2.2.1. Schaltschemen

Die Schaltung der Motoren mit konstantem Moment ist D/YY und mit variablem Moment ist Y/YY für Dahlander-Schaltung. Für Motoren mit getrennter Wicklung ist die Schaltung Y/Y für konstanten und variablen Moment. Zweitourige Motoren läuft man aus kleinerer Drehzahl an und dann schaltet man auf höhere Drehzahl. Die Motoren in der Dahlander-Schaltung sind nur für direkten Anlauf geeignet. Auf Anfrage ist es möglich auch den Y/D Anlauf zu realisieren. Die Klemmbrettschaltungen sind in folgender Tabellen 2.10. und 2.11. dargestellt:

Tablica 2.16. / Table 2.16. / Tabelle 2.16..

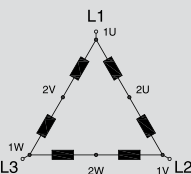
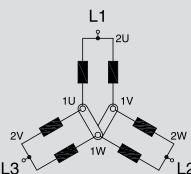
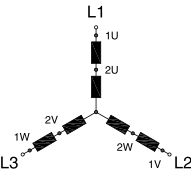
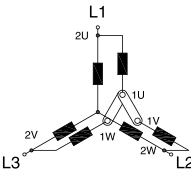
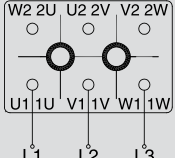
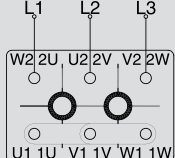
TROFAZNI DVOBRZINSKI MOTORI S JEDNIM NAMOTOM THREE-PHASE DOUBLE SPEED MOTORS WITH ONE WINDING DREIPHASIGE ZWEITOURIGE MOTOREN MIT EINER WICKLUNG		
	NIŽA BRZINA LOW SPEED NIEDRIGE DREHZAHL	VIŠA BRZINA HIGHER SPEED HOHE DREHZAHL
DAHLANDER SPOJ D/YY - KONSTANTNI MOMENT NA OBJE BRZINE DAHLANDER CONNECTION D/YY CONSTANT TORQUE ON BOTH SPEEDS DAHLANDER-SCHALTUNG D/YY KONSTANTES MOMENT AUF BEIDEN DREHZAHLN		
DAHLANDER SPOJ Y/YY - VENTILATORSKA KARAKTERISTIKA MOMENTA DAHLANDER CONNECTION Y/YY FAN RATED TORQUE CHARACTERISTIC DAHLANDER-SCHALTUNG Y/YY LEISTUNGSSTUFUNG FÜR LÜFTERANTRIEBSMOTOREN		
SHEMA PRIKLJUČKA NA MREŽU POWER SUPPLY CONNECTION DIAGRAM KLEMMENSCHALTPLAN AUFS NETZ		

Tablica 2.17. / Table 2.17. / Tabelle 2.17.

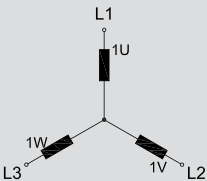
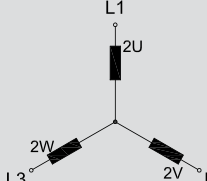
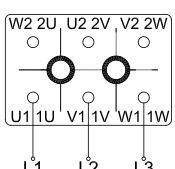
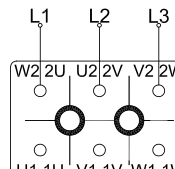
TROFAZNI DVOBRZINSKI MOTORI S DVA ODVOJENA NAMOTA THREE-PHASE DOUBLE SPEED MOTORS WITH TWO SEPARATE WINDINGS DREIPHASIGE ZWEITOURIGE MOTOREN MIT ZWEI GETRENNTEN WICKLUNGEN		
	NIŽA BRZINA LOWER SPEED NIEDRIGE DREHZAHL	VIŠA BRZINA HIGHER SPEED HOHE DREHZAHL
DVA ODVOJENA NAMOTA Y/Y TWO SEPARATE WINDINGS Y/Y ZWEI GETRENNTE WICKLUNGEN Y/Y		
SHEMA PRIKLJUČKA NA MREŽU POWER SUPPLY CONNECTION DIAGRAM KLEMMENSCHALTPLAN AUFS NETZ		

Tablica 2.18. / Table 2.18. / Tabelle 2.18.

Standardna izvedba	Standard design	Standardausführung
<p>Serije i veličine: Motori serije 5 u siluminskom, tlačno lijevanom orebrenom kućištu s odlivenim nogama u veličinama 56-160 Motori serije 7 u orebrenom kućištu od sivog lijeva s montažnim nogama u veličinama 180-315 (Veličine 132-160 na upit)</p>	<p>Series and frame sizes: <i>Seris 5 motors in die casted aluminum alloy ribbed housing with die casted feets in IEC frame sizes 56 – 160</i> <i>Serises 7 motors in cast iron ribbed housing with demountable feet in IEC frame sizes 180 – 315 (IEC frame size 132-160 on request)</i></p>	<p>Baureihen und Baugrößen: Motorenbaureihe 5 im gerippten Alu-Druckgussgehäuse mit gegossenen Füßen in Baugrößen 56-160 Motorenbaureihe 7 im gerippten Graugussgehäuse mit angeschraubten Füßen in Baugrößen 180-315 (Baugröße 132-160 auf Anfrage)</p>
<p>Broj polova: Višebrzinski motori : <ul style="list-style-type: none"> • za konstantni protumoment serija AZP • za primjenu u ventilaciji serija AZPV <ul style="list-style-type: none"> - 4/2, 8/4, 12/6 u Dahlander spoju s jednim namotom - 6/4, 8/6, 6/2, 8/2 s dva odvojena namota - 8/4/2, 6/4/2, 8/6/4 s dva odvojena namota (jedan u Dahlander spoju) </p>	<p>Number of poles: <i>Multi-speed motors:</i> <ul style="list-style-type: none"> • <i>series AZP with constant torque at both speeds</i> • <i>fan rated AZPV series</i> <ul style="list-style-type: none"> - <i>4/2, 8/4, 12/6 – one winding in Dahlander connection</i> - <i>6/4, 8/6, 6/2, 8/2 – two separate windings</i> - <i>8/4/2, 6/4/2, 8/6/4 – two separate windings (one in Dahlander connection)</i> </p>	<p>Polzahlen: Mehrtourige Motoren: <ul style="list-style-type: none"> • Baureihe AZP für konstantes Moment • Baureihe AZPV für die Ventilationsanwendung <ul style="list-style-type: none"> - 4/2, 8/4, 12/6 – in Dahlander-Schaltung - mit einer Wicklung - 6/4, 8/6, 6/2, 8/2 – mit zwei getrennten Wicklungen - 8/4/2, 6/4/2, 8/6/4 – mit zwei getrennten Wicklungen (eine in Dahlander-Schaltung) </p>
<p>Oblici ugradnje: IM B3, B5, B35, B14 i B34 (dva posljednja do uključivo veličine 132)</p>	<p>Mounting arrangements: <i>IM B3, B5, B35, B14 and B34 (last two available up to frame size 132)</i></p>	<p>Bauformen: IM B3, B5, B35, B14 und B34 (die zwei letzten bis einschließlich der Bgr.132)</p>
<p>Priključni ormarić: metalni, gledano sa strane pogonskog vratila u oblicima IM B3, B35 i B34 smješten gore uvodnice i čepovi sa „M“ navojem prema tehničkim razjašnjenjima</p>	<p>Terminal box: <i>metal, viewed from drive end side in mounting arrangements IMB3, B35 and B34 situated on top cable glands and cable plugs with „M“ thread according to technical explanations</i></p>	<p>Klemmenkasten: aus Metall, betrachtet von der Antriebswellenseite in Bauformen IMB3, B35 und B34 oben aufgestellt, Kabelverschraubungen und Stopfen mit metrischem Gewinde M nach technischen Erläuterungen</p>
<p>Vrsta pogona: S1; (za okolinu -20°C do +40°C i postav do 1000 m nm)</p>	<p>Duty type: <i>S1 (for ambient from -20°C to +40°C and altitude up to 1000 m above sea level)</i></p>	<p>Betriebsart: S1 (für die Umgebung von -20°C bis +40°C und die Aufstellung bis 1000m über dem Meeresspiegel)</p>
<p>Napon i frekvencija: 400 V / 50 Hz</p>	<p>Voltage and frequency: <i>400 V / 50 Hz</i></p>	<p>Spannung u.Frequenz: 400 V / 50 Hz</p>
<p>Iskoristivost: u klasi IE1 prema IEC 60034-30</p>	<p>Efficiency: <i>in class IE1 according to IEC 60034-30</i></p>	<p>Wirkungsgrad: in Wirkungsgradklasse IE1 nach der IEC 60034-30 Vereinbarung</p>
<p>Stupanj zaštite: IP55</p>	<p>Protection index: <i>IP55</i></p>	<p>Schutzart: IP55</p>
<p>Klasa izolacije: F (zagrijavanje u B)</p>	<p>Insulation class: <i>F (rise in B)</i></p>	<p>Isolationsklasse: F (Erwärmung in B)</p>
<p>Ton boje: RAL 5010</p>	<p>Colour tone: <i>RAL 5010</i></p>	<p>Farbton: RAL 5010</p>

2.2.2. Dvobrzinski motori s konstantnim momentom na obje brzine – DAHLANDER

2.2.2. Two-speed motors with constant torque at both SPEEDS – DAHLANDER

2.2.2. Zweitourige Motoren mit konstantem Lastmoment auf beiden Drehzahlen – DAHLANDER

Tablica 2.19. / Table 2.19. / Tabelle 2.19.

2p=4/2		Motor type	D/YY		50 Hz				1500/3000 min ⁻¹		m (kg)
P (kW)			n (min ⁻¹)		I _n (A)		$\frac{I_k}{I_n}$		$\frac{M_k}{M_n}$		
2p=4	2p=2		2p=4	2p=2	2p=4	2p=2	2p=4	2p=2	2p=4	2p=2	
0.15	0.2	5AZP 63B-4/2	1350	2770	0.55	0.52	3.3	4.1	2.4	2.7	4.3
0.22	0.35	5AZP 71A-4/2	1430	2820	1.1	1.4	3.0	3.2	1.8	1.7	5.4
0.3	0.5	5AZP 71B-4/2	1390	2720	1.5	1.5	3.5	3.7	2.0	2.0	5.8
0.45	0.7	5AZP 80A-4/2	1390	2730	1.3	1.8	4.5	4.4	2.0	2.0	9
0.65	1	5AZP 80B-4/2	1420	2800	1.9	2.5	4.0	5.0	2.0	2.0	10
1	1.2	5AZP 90S-4/2	1370	2740	2.5	3.5	3.8	3.8	2.1	2.2	12.7
1.4	1.8	5AZP 90L-4/2	1380	2780	3.4	4.5	4.2	4.0	1.8	2.0	15.7
1.8	2.2	5AZP 100LA-4/2	1420	2880	4.3	5.6	4.6	4.4	2.0	2.2	22
2.5	3	5AZP 100LB-4/2	1400	2860	5.8	7.9	6.0	6.0	2.7	3.0	25
3.2	4	5AZP 112M-4/2	1430	2900	7.2	10.2	5.5	5.5	2.1	2.2	33
4.5	5.5	5AZP 132S-4/2	1430	2890	9.2	12	5.6	6.0	2.1	2.2	40
6.5	8	5AZP 132M-4/2	1440	2900	13	17	6.1	5.8	2.6	2.4	50
9.5	11.5	5AZP 160M-4/2	1460	2940	19	25.5	6.0	7.3	2.2	1.8	83
13	15	5AZP 160L-4/2	1460	2930	25.5	30	6.3	8.0	2.3	2.8	98
15	18.5	7AZP 180M-4/2	1470	2950	29	38.5	7.6	8.0	2.4	2.5	183
18.5	20	7AZP 180L-4/2	1460	2950	35.5	41	7.8	8.0	2.0	2.0	199
22	25	7AZP 180LA-4/2	1470	2950	41.5	50	7.8	8.0	2.0	2.0	225
26	32	7AZP 200L-4/2	1470	2955	48.5	56	7.5	8.0	2.5	2.5	250
32	38	7AZP 225S-4/2	1475	2960	58	67	5.4	7.4	1.8	2.2	322
38	45	7AZP 225M-4/2	1475	2960	69	78	5.4	7.5	1.8	2.3	354
45	55	7AZP 250M-4/2	1480	2970	82	93.5	6.3	7.4	1.9	2.2	440
55	70	7AZP 280S-4/2	1480	2965	100	120	6.4	6.6	1.8	1.8	550
70	85	7AZP 280M-4/2	1480	2970	125	145	6.5	7.2	1.9	2.0	610

Tablica 2.20. / Table 2.20. / Tabelle 2.20.

2p=8/4		Motor type	D/YY		50 Hz				750/1500 min ⁻¹		m (kg)
P (kW)			n (min ⁻¹)		I _n (A)		$\frac{I_k}{I_n}$		$\frac{M_k}{M_n}$		
2p=8	2p=4		2p=8	2p=4	2p=8	2p=4	2p=8	2p=4	2p=8	2p=4	
0.04	0.09	5AZP 63B-8/4	660	1390	0.5	0.4	2.0	3.0	3.0	2.9	4.3
0.07	0.15	5AZP 71A-8/4	660	1370	0.6	0.5	2.5	3.0	1.8	1.8	5.4
0.1	0.2	5AZP 71B-8/4	660	1370	0.7	0.6	2.5	3.0	1.8	1.8	6.3
0.22	0.37	5AZP 80A-8/4	680	1350	1.1	1.0	2.5	3.5	1.9	1.8	8.5
0.3	0.55	5AZP 80B-8/4	680	1370	1.5	1.4	3.0	3.5	1.8	1.8	8.8
0.4	0.7	5AZP 90S-8/4	680	1350	2.0	1.8	3.0	3.5	1.8	1.8	12.8
0.5	1	5AZP 90L-8/4	660	1350	2.8	2.6	3.0	3.8	1.9	1.8	14
0.65	1.3	5AZP 100LA-8/4	700	1420	2.8	3.0	3.0	4.0	1.5	1.5	22
0.8	1.6	5AZP 100LB-8/4	700	1420	3.8	3.8	3.0	4.5	1.8	1.8	25
1.4	2.4	5AZP 112M-8/4	680	1370	4.8	5.5	3.5	4.5	1.8	1.8	29
2.2	3.3	5AZP 132S-8/4	700	1400	5.8	8.2	4.5	4.3	2.2	2.1	35
3	4.4	5AZP 132M-8/4	710	1430	9.5	9.8	3.8	5.3	1.8	2.0	43
4.5	6	5AZP 160MA-8/4	720	1450	11	15.3	5.0	6.0	1.8	1.8	65
6	8.5	5AZP 160MB-8/4	720	1450	14	20.5	5.0	6.0	1.8	1.8	75
7.5	10	5AZP 160L-8/4	720	1450	17	20	5.5	7.0	2.0	2.0	95
10	15	7AZP 180L-8/4	730	1460	22	28.5	6.0	7.5	2.1	2.0	195
12.5	18.5	7AZP 180LA-8/4	720	1450	27.5	35	6.0	7.5	2.1	2.0	225
16	26	7AZP 200L-8/4	710	1440	41.5	50	6.0	7.3	1.9	1.9	245
22	34	7AZP 225S-8/4	720	1470	62	62.5	5.6	7.5	1.8	1.8	310
25	38	7AZP 225M-8/4	735	1480	56	66	5.6	7.6	1.8	1.8	330
31	46	7AZP 250M-8/4	740	1480	67	86	5.6	7.6	1.6	1.8	410
37	55	7AZP 280S-8/4	740	1485	81	95	5.6	8.0	1.5	1.8	545
45	67	7AZP 280M-8/4	740	1485	99	115	6.0	8.8	1.8	2.0	595

2.2.3. Dvobrzinski motori za pogon ventilatora – DAHLANDER
2.2.3. Two-speed fan rated motors – DAHLANDER
2.2.3. Zweitourige Motoren für Lüfterantrieb – DAHLANDER
Tablica 2.21. / Table 2.21. / Tabelle 2.21.

2p=4/2		Motor type	Y/YY		50 Hz				1500/3000 min ⁻¹		m (kg)
P (kW)			n (min ⁻¹)		I _n (A)		$\frac{I_k}{I_n}$		$\frac{M_k}{M_n}$		
2p=4	2p=2		2p=4	2p=2	2p=4	2p=2	2p=4	2p=2	2p=4	2p=2	
0.09	0.35	5AZPV 71A-4/2	1390	2770	0.3	1.4	3.0	3	1.6	1.7	5.4
0.1	0.5	5AZPV 71B-4/2	1390	2720	0.4	1.6	3.5	4.0	2.0	2.5	6.3
0.15	0.7	5AZPV 80A-4/2	1420	2790	0.4	1.7	4.6	4.2	1.9	1.9	9
0.25	1	5AZPV 80B-4/2	1410	2830	0.6	2.6	3.5	4.5	2.0	1.9	10
0.35	1.2	5AZPV 90S-4/2	1400	2740	0.8	3.5	4.0	4.5	1.9	2.0	12.7
0.5	1.8	5AZPV 90L-4/2	1400	2800	1.1	4.9	4.0	4.5	1.9	2.0	14
0.7	2.2	5AZPV 100LA-4/2	1430	2900	1.5	6.0	4.5	4.9	2.0	2.5	19.5
0.8	3	5AZPV 100LB-4/2	1420	2860	1.8	7.0	5.0	5.5	1.9	2.5	25
1.1	4	5AZPV 112M-4/2	1430	2890	2.4	8.3	5.0	5.6	1.9	2.2	33
1.5	5.5	5AZPV 132S-4/2	1440	2900	3.3	12.5	5.2	6.6	2.1	2.3	40
2	8	5AZPV 132M-4/2	1450	2900	4.0	17	5.8	6.6	2.1	2.3	49
2.9	11.5	5AZPV 160M-4/2	1470	2930	5.7	23.5	5.8	7.2	2.0	2.4	80
3.8	15	5AZPV 160L-4/2	1470	2930	7.7	32	6.5	8.0	2.3	2.9	95
4.6	18.5	7AZPV 180M-4/2	1490	2940	9.5	39	7.5	8.0	2.4	2.5	185
5.5	20	7AZPV 180L-4/2	1480	2960	10	43.5	7.5	8.0	2.5	2.9	199
7.5	25	7AZPV 180LA-4/2	1460	2940	14	50	7.5	8.0	2.5	2.9	225
8	32	7AZPV 200L-4/2	1470	2955	15	56	6.0	7.9	1.6	2.5	250
9	38	7AZPV 225S-4/2	1475	2960	17	67	5.7	7.4	1.4	2.2	322
11	45	7AZPV 225M-4/2	1475	2960	20	78	5.8	7.5	1.5	2.3	354
13.5	55	7AZPV 250M-4/2	1480	2965	25	94	7.0	7.8	1.6	2.2	440
16	70	7AZPV 280S-4/2	1480	2965	29	121	6.9	6.6	1.6	1.8	550
20	85	7AZPV 280M-4/2	1485	2970	35	146	7.2	7.2	1.7	2.0	610

Tablica 2.22. / Table 2.22. / Tabelle 2.22.

2p=8/4		Motor type	Y/YY		50 Hz				750/1500 min ⁻¹		m (kg)
P (kW)			n (min ⁻¹)		I _n (A)		$\frac{I_k}{I_n}$		$\frac{M_k}{M_n}$		
2p=8	2p=4		2p=8	2p=4	2p=8	2p=4	2p=8	2p=4	2p=8	2p=4	
0.05	0.22	5AZPV 71A-8/4	675	1400	0.3	0.85	2.0	3.0	1.3	1.7	5.4
0.07	0.3	5AZPV 71B-8/4	650	1380	0.4	1.1	2.0	3.0	1.4	1.8	6.3
0.12	0.5	5AZPV 80A-8/4	685	1380	0.6	1.3	2.2	3.6	1.5	1.8	9
0.18	0.7	5AZPV 80B-8/4	660	1390	0.75	2.2	2.5	4.0	1.6	1.8	10
0.25	1.1	5AZPV 90S-8/4	690	1400	1.25	3.1	2.5	4.0	1.6	1.8	12.7
0.35	1.4	5AZPV 90L-8/4	680	1400	1.4	3.5	2.5	4.1	1.7	2.1	15.7
0.5	2	5AZPV 100LA-8/4	700	1420	2.0	4.8	3.0	4.5	1.7	2.2	22
0.6	2.5	5AZPV 100LB-8/4	710	1430	2.4	5.9	3.1	5.2	1.9	2.2	25
0.9	3.6	5AZPV 112M-8/4	710	1440	3.2	8.0	3.1	5.5	1.7	2.0	33
1.1	4.6	5AZPV 132S-8/4	720	1450	3.5	9.5	3.5	6.0	1.7	2.0	40
1.5	6	5AZPV 132M-8/4	725	1450	4.7	12.5	4.0	6.0	1.9	2.3	49
1.7	7	5AZPV 160MA-8/4	730	1460	5.0	13.8	4.0	6.0	1.6	2.1	65
2.2	8.5	5AZPV 160MB-8/4	720	1430	5.3	17.5	4.0	6.0	1.5	1.8	75
3	12	5AZPV 160L-8/4	730	1470	9.0	24	4.0	6.6	1.8	2.2	95
3.7	16.2	7AZPV 180M-8/4	735	1470	13	36	5.0	7.5	2.0	2.2	185
4.5	18.5	7AZPV 180L-8/4	735	1470	15	40	5.0	7.5	2.7	3.0	199
5.5	22	7AZPV 180LA-8/4	735	1470	17	45	5.0	7.5	2.7	3.0	225
7	28	7AZPV 200L-8/4	730	1470	20	51	4.1	7.1	2.3	2.6	250
8.5	37	7AZPV 225S-8/4	740	1470	25.5	71	4	6	2	2	322
10	42	7AZPV 225M-8/4	735	1470	28	76	4.1	6.0	1.3	2.7	354
12	48	7AZPV 250M-8/4	735	1480	30	86	4.5	8.2	1.4	2.8	440
15	63	7AZPV 280S-8/4	740	1480	45	118	4.3	6.9	2	2.4	618
18	75	7AZPV 280M-8/4	740	1485	42	134	4.7	6.9	1.4	2.8	650

2.2.4. Dvobrzinski motori za pogon ventilatora – DVA ODVOJENA NAMOTA

2.2.4. Two-speed fan rated motors - TWO SEPARATE WINDINGS

2.2.4. Zweitourige Motoren für Lüfterantriebe - ZWEI GETRENNTEN WICKLUNGEN

Tablica 2.23. / Table 2.23. / Tabelle 2.23.

2p=4/2		Motor type	Y/Y		50 Hz				1500/3000 min ⁻¹		m (kg)
P (kW)			n (min ⁻¹)		I _n (A)		$\frac{I_k}{I_n}$		$\frac{M_k}{M_n}$		
2p=4	2p=2		2p=4	2p=2	2p=4	2p=2	2p=4	2p=2	2p=4	2p=2	
0.037	0.18	5AZPVE 71A-4/2	1430	2890	0.35	1.1	3.2	3.2	2	1.8	5.5
0.055	0.25	5AZPVE 71B-4/2	1430	2890	0.4	1.2	3.2	3.2	2	1.8	6.3
0.075	0.37	5AZPVE 80A-4/2	1430	2900	0.4	1.3	4.0	4.8	2	1.8	8.2
0.12	0.55	5AZPVE 80B-4/2	1470	2890	0.6	1.5	4.5	4.8	2	1.7	10
0.15	0.75	5AZPVE 90S-4/2	1440	2850	0.5	2.1	4.7	4.9	2.1	2	12.7
0.22	1.2	5AZPVE 90L-4/2	1440	2820	0.7	2.8	4.5	4.8	1.9	1.9	15.7
0.3	1.5	5AZPVE 100LA-4/2	1450	2930	0.75	3.5	4.6	4.9	1.7	1.6	22
0.4	2.2	5AZPVE 100LB-4/2	1450	2900	0.9	4.9	4.9	5	1.6	1.8	25
0.55	3	5AZPVE 112M-4/2	1440	2920	1.1	6.5	5.4	6	1.9	2	33
0.75	4	5AZPVE 132S-4/2	1460	2880	2	8.5	5.3	5.3	1.8	1.7	40
1.1	5.5	5AZPVE 132M-4/2	1470	2900	2.4	10.5	5.2	6.8	1.6	2.2	49
1.5	7.5	5AZPVE 160M-4/2	1475	2940	3.5	15.5	7.0	8.8	2.1	2.6	80
2.2	11	5AZPVE 160L-4/2	1470	2950	4.4	20.5	6.9	8.8	2.1	2.6	95
3	15	7AZPVE 180M-4/2	1460	2920	6.2	28.5	4.6	6.9	1.6	2.3	185
4	18.5	7AZPVE 180L-4/2	1460	2930	8.0	35	4.6	5.9	1.6	2.6	199
4.5	22	7AZPVE 180LA-4/2	1460	2920	8.7	40	4.6	7.8	1.6	2.6	225
5	25	7AZPVE 200L-4/2	1465	2930	9.5	48	4.6	7.5	1.6	2.6	250
6	30	7AZPVE 225S-4/2	1465	2930	11.5	55	4.6	7.5	1.6	2.6	322
7.5	35	7AZPVE 225M-4/2	1470	2935	14.5	65	4.6	7.5	1.6	2.6	354
9.5	45	7AZPVE 250M-4/2	1470	2935	18	85	4.6	7.5	1.6	2.6	440
12.5	55	7AZPVE 280S-4/2	1475	2940	24	105	4.6	7.5	1.6	2.6	550
15	70	7AZPVE 280M-4/2	1475	2940	28.5	135	4.6	7.5	1.6	2.6	610

Tablica 2.24. / Table 2.24. / Tabelle 2.24.

2p=8/4		Motor type	Y/Y		50 Hz				750/1500 min ⁻¹		m (kg)
P (kW)			n (min ⁻¹)		I _n (A)		$\frac{I_k}{I_n}$		$\frac{M_k}{M_n}$		
2p=8	2p=4		2p=8	2p=4	2p=8	2p=4	2p=8	2p=4	2p=8	2p=4	
0.025	0.12	5AZPVE 71A-8/4	700	1410	0.3	0.7	2.0	2.9	1.6	1.6	5.5
0.037	0.18	5AZPVE 71B-8/4	700	1410	0.35	0.8	2.0	2.9	1.6	1.6	6.3
0.055	0.25	5AZPVE 80A-8/4	720	1430	0.4	1.0	3.0	3.7	1.8	1.8	9
0.075	0.37	5AZPVE 80B-8/4	710	1440	0.6	1.3	3.0	4.2	1.8	1.8	10
0.11	0.55	5AZPVE 90S-8/4	720	1440	0.8	1.7	2.8	4.5	1.7	1.8	12.7
0.15	0.75	5AZPVE 90L-8/4	720	1450	0.85	2.2	2.8	4.5	1.8	1.9	15.7
0.22	1.1	5AZPVE 100LA-8/4	730	1460	1.35	3.0	2.9	4.5	1.9	1.9	22
0.30	1.5	5AZPVE 100LB-8/4	730	1450	1.75	4.2	2.8	4.7	1.9	1.9	25
0.40	2.2	5AZPVE 112M-8/4	710	1440	1.8	5.2	3.2	5.2	1.8	1.9	33
0.55	3	5AZPVE 132S-8/4	730	1460	2.0	6.4	3.2	6.2	1.3	1.9	40
0.75	4	5AZPVE 132M-8/4	730	1460	2.4	8.7	3.3	6.3	1.4	1.9	49
1.1	5.5	5AZPVE 160M-8/4	740	1460	4.8	11	4.4	6.4	2.4	2.1	80
1.5	7.5	5AZPVE 160L-8/4	730	1470	6.0	14.5	5.2	6.4	3.0	2.0	95
2.2	11	7AZPVE 180M-8/4	730	1470	6.5	22	3.6	5.2	1.6	2.3	185
3	15	7AZPVE 180L-8/4	730	1470	9.5	30	4.2	7.2	2.0	2.6	199
4	18.5	7AZPVE 180LA-8/4	720	1450	12	35.5	5.1	7.0	2.6	2.2	225
4.25	20	7AZPVE 200L-8/4	740	1460	13.5	40	5.1	7.0	2.5	2.3	250
5	25	7AZPVE 225S-8/4	740	1460	15	50	5.1	7.0	2.5	2.3	320
6	30	7AZPVE 225M-8/4	740	1465	18	60	5.0	7.0	2.5	2.3	355
7.5	35	7AZPVE 250M-8/4	740	1470	23	70	5.0	7.0	2.5	2.3	440
9.5	45	7AZPVE 280S-8/4	740	1470	30	90	5.0	7.0	2.5	2.3	550
11	55	7AZPVE 280M-8/4	740	1470	35	110	5.0	7.0	2.5	2.3	610

2.2.5. Dvobrzinski motori s konstantnim momentom na obje brzine – DVA ODVOJENA NAMOTA
2.2.5. Two-speed motors with constant torque AT both speeds - TWO SEPARATE WINDINGS
2.2.5. Zweitourige Motoren mit konstantem Moment auf beiden Drehzahlen - ZWEI GETRENNTEN WICKLUNGEN
Tablica 2.25. / Table 2.25. / Tabelle 2.25.

2p=6/4		Motor type	Y/Y		50 Hz				1000/1500 min ⁻¹		m (kg)
P (kW)			n (min ⁻¹)		I _n (A)		$\frac{I_k}{I_n}$		$\frac{M_k}{M_n}$		
2p=6	2p=4		2p=6	2p=4	2p=6	2p=4	2p=6	2p=4	2p=6	2p=4	
0.15	0.3	5AZP 71C-6/4	920	1440	0.8	1.35	2.1	2.9	1.6	2	6.5
0.25	0.35	5AZP 80A-6/4	950	1440	1.1	1.4	2.7	3.6	1.6	2.0	9
0.37	0.55	5AZP 80B-6/4	930	1420	1.35	1.7	3.2	3.8	1.6	1.8	10
0.45	0.75	5AZP 90S-6/4	930	1430	1.7	2.3	3.2	3.9	1.5	1.8	12.7
0.6	1	5AZP 90L-6/4	950	1430	2.35	2.9	3.0	3.7	1.8	1.8	13.7
0.9	1.3	5AZP 100LA-6/4	955	1460	3.0	3.8	3.6	4.8	1.7	2.0	22
1.2	1.7	5AZP 100LB-6/4	950	1455	3.7	4.6	3.6	5.2	1.7	2.2	25
1.6	2.3	5AZP 112M-6/4	965	1470	4.5	6.1	4.0	5.2	1.7	1.7	33
2.3	3.1	5AZP 132S-6/4	970	1470	6.2	7.0	4.1	5.5	1.7	1.9	40
2.9	4.3	5AZP 132M-6/4	960	1460	7.0	9.0	4.4	5.5	1.9	1.9	49
4.4	6.5	5AZP 160M-6/4	975	1475	11	14	5.0	6.2	1.9	2.0	80
6	8.5	5AZP 160L-6/4	970	1470	15.2	18	5.2	6.4	2.2	2.5	95
8.6	13	7AZP 180M-6/4	980	1470	21	27	5.6	6.8	2.3	2.3	185
10	16	7AZP 180L-6/4	975	1470	22	32	5.6	7.0	2.5	2.5	199
12.5	20	7AZP 180LA-6/4	980	1480	29	40	5.6	7.0	3	2.7	225
14	21	7AZP 200L-6/4	980	1475	28	39	7.0	7.0	2.2	1.9	250
19	29	7AZP 225S-6/4	980	1480	37	53	6.8	7.5	2.0	2.2	322
22	33	7AZP 225M-6/4	975	1475	50	61	6.8	7.2	2.0	2.1	354
27	40	7AZP 250M-6/4	985	1480	49	69	7.3	7.9	2.0	2.0	440
33	50	7AZP 280S-6/4	985	1485	60	86	7.5	8.0	1.8	2.0	555
38	57	7AZP 280M-6/4	985	1485	68	97	7.6	7.8	2.0	2.1	600

Tablica 2.26. / Table 2.26. / Tabelle 2.26.

2p=8/6		Motor type	Y/Y		50 Hz				750/1000 min ⁻¹		m (kg)
P (kW)			n (min ⁻¹)		I _n (A)		$\frac{I_k}{I_n}$		$\frac{M_k}{M_n}$		
2p=8	2p=6		2p=8	2p=6	2p=8	2p=6	2p=8	2p=6	2p=8	2p=6	
0.18	0.3	5AZP 80B-8/6	710	950	0.85	1.2	2.2	2.7	1.5	1.7	10
0.3	0.45	5AZP 90S-8/6	690	950	1.5	2.0	2.5	3.0	1.8	1.8	12.7
0.4	0.55	5AZP 90L-8/6	700	940	1.75	2.0	2.5	3.0	1.8	1.8	15.7
0.65	1	5AZP 100L-8/6	700	940	2.5	3.1	3.3	3.8	1.8	1.5	22
1	1.4	5AZP 112M-8/6	710	970	3.7	4.6	4.0	4.5	1.8	1.5	29
1.4	1.7	5AZP 132S-8/6	710	970	4.4	4.7	4.5	5.0	1.7	1.8	39
1.8	2.8	5AZP 132MA-8/6	710	970	5.8	7.5	4.5	5.5	1.7	1.9	45
2.5	3.4	5AZP 132MB-8/6	720	970	7.6	8.6	5.0	5.5	1.8	1.9	49
3.4	5	5AZP 160M-8/6	730	980	9.0	12	5.1	6.5	1.9	1.8	78
5	7	5AZP 160L-8/6	730	980	13	16	5.1	6.8	1.8	1.8	98
7	9	7AZP 180L-8/6	720	950	17	19	5.5	6.8	1.8	1.7	165
9	11.5	7AZP 180LA-8/6	730	980	21	24	5.5	6.8	1.8	1.7	220
9.5	13	7AZP 200LA-8/6	730	980	23	27	5.9	6.7	1.7	1.7	230
11	15	7AZP 200LB-8/6	735	985	27	31	6.1	6.6	1.8	1.7	261
15	20	7AZP 225M-8/6	735	985	35	40	6.2	6.7	1.8	1.6	305
19	26	7AZP 250M-8/6	735	985	40	50	7.4	8.0	1.8	1.8	395
24	32	7AZP 280S-8/6	740	990	51	61	7.5	8.2	2.0	1.9	510
29	38	7AZP 280M-8/6	740	990	59	71	7.2	8.2	1.9	1.9	550

2.2.6. Dvobrzinski motori za pogon ventilatora – DVA ODVOJENA NAMOTA

2.2.6. Two-speed fan rated motors - TWO SEPARATE WINDINGS

2.2.6. Zweitourige Lüfterantriebsmotoren - ZWEI GETRENNTEN WICKLUNGEN

Tablica 2.27. / Table 2.27. / Tabelle 2.27.

2p=6/4		Motor type	Y/Y		50 Hz				1000/1500 min ⁻¹		m (kg)
P (kW)			n (min ⁻¹)		I _n (A)		$\frac{I_k}{I_n}$		$\frac{M_k}{M_n}$		
2p=6	2p=4		2p=6	2p=4	2p=6	2p=4	2p=6	2p=4	2p=6	2p=4	
0.06	0.18	5AZPV 71A-6/4	930	1400	0.4	0.7	2.2	3.5	1.4	1.5	5.4
0.09	0.25	5AZPV 71B-6/4	930	1410	0.45	0.9	2.2	2.9	1.4	1.5	6.3
0.12	0.37	5AZPV 80A-6/4	950	1420	0.55	1.15	2.5	3.8	1.4	1.9	9
0.18	0.55	5AZPV 80B-6/4	940	1420	0.8	1.7	3.0	4.0	1.5	1.9	10
0.25	0.75	5AZPV 90S-6/4	950	1420	1.0	2.4	2.8	3.8	1.5	1.8	11.4
0.37	1.1	5AZPV 90L-6/4	950	1420	1.4	3.0	2.9	3.6	1.6	1.7	13.6
0.55	1.5	5AZPV 100LA-6/4	960	1440	1.9	4.3	3.3	4.7	1.6	1.9	22
0.75	2.2	5AZPV 100LB-6/4	950	1430	2.5	5.3	3.0	4.8	1.5	2.2	25
0.9	3	5AZPV 112M-6/4	975	1450	3.3	6.9	4.0	5.5	1.5	2.0	33
1.2	4	5AZPV 132S-6/4	960	1440	3.5	9.0	4.1	5.7	1.5	2.2	40
1.7	5.5	5AZPV 132M-6/4	970	1460	4.5	12	4.5	6.0	2.0	2.1	49
2.5	7.5	5AZPV 160M-6/4	980	1465	6.0	15	5.0	6.0	1.6	2.0	80
3.3	11	5AZPV 160L-6/4	975	1470	8.0	22.5	5.5	6.5	1.9	2.2	95
5	14	7AZPV 180M-6/4	985	1475	13	30	5.8	6.6	2.2	2.4	183
7	18.5	7AZPV 180L-6/4	985	1460	19	36	5.8	6.8	2.2	2.4	199
9	22	7AZPV 180LA-6/4	980	1480	23	49	5.8	6.8	2.2	2.4	225
8	24	7AZPV 200L-6/4	980	1475	16.5	44	6.9	6.7	1.9	1.9	275
11	33	7AZPV 225S-6/4	985	1475	26.5	60	7.3	7.1	1.9	2.0	322
14	37	7AZPV 225M-6/4	985	1475	31	68	7.3	6.8	2.0	2.0	354
17	45	7AZPV 250M-6/4	985	1480	23	53	5	7.8	2.0	2.5	465
21	56	7AZPV 280S-6/4	985	1480	38	95	7.8	7.6	1.8	2.0	555
24	62	7AZPV 280M-6/4	985	1480	44	105	7.8	7.5	1.8	2.0	600

Tablica 2.28. / Table 2.28. / Tabelle 2.28.

2p=8/6		Motor type	Y/Y		50 Hz				750/1000 min ⁻¹		m (kg)
P (kW)			n (min ⁻¹)		I _n (A)		$\frac{I_k}{I_n}$		$\frac{M_k}{M_n}$		
2p=8	2p=6		2p=8	2p=6	2p=8	2p=6	2p=8	2p=6	2p=8	2p=6	
0.09	0.25	5AZPV 80A-8/6	720	955	0.6	1.15	3.0	3.5	1.8	1.6	8.5
0.15	0.37	5AZPV 80B-8/6	720	940	0.9	1.4	3.0	3.5	1.8	1.8	9.7
0.2	0.55	5AZPV 90S-8/6	700	930	1.2	2.0	3.0	3.5	1.8	1.8	12.7
0.3	0.75	5AZPV 90L-8/6	710	910	1.7	2.6	3.0	3.5	1.8	1.8	15.7
0.4	1	5AZPV 100L-8/6	710	950	1.35	3.3	3.4	4.3	1.8	1.7	22
0.6	1.4	5AZPV 112M-8/6	710	960	2.2	3.9	3.5	4.9	1.5	2.0	33
0.9	2.2	5AZPV 132S-8/6	730	965	3.3	6.0	3.6	4.7	2.0	2.0	39
1.1	2.8	5AZPV 132MA-8/6	730	970	3.8	7.5	4.1	5.1	2.0	2.0	45
1.5	3.5	5AZPV 132MB-8/6	730	970	4.5	8.5	3.8	6.1	1.6	2.5	49
2.6	5.5	5AZPV 160M-8/6	730	975	7.3	13	4.5	6.0	1.7	2.0	78
3	8	5AZPV 160L-8/6	740	980	9.0	19	5.0	6.5	1.7	2.0	98
5	11	7AZPV 180L-8/6	730	970	15	22	5.5	7.0	1.7	2.0	165
6.3	13.5	7AZPV 180LA-8/6	730	970	18	27	5.5	7.0	1.7	2.0	220
6.5	15	7AZPV 200LA-8/6	735	980	16	31	6.1	6.4	1.7	1.6	230
8	17	7AZPV 200LB-8/6	735	980	19	34	6.1	6.4	1.7	1.6	270
11	23	7AZPV 225M-8/6	735	985	26.5	49	5	6.5	2.4	2.7	305
14	30	7AZPV 250M-8/6	740	985	29	56	7.5	7.6	1.8	1.8	395
17	37	7AZPV 280S-8/6	740	985	36	68	7.7	7.7	2.0	1.8	510
20	44	7AZPV 280M-8/6	740	985	41	80	7.3	7.8	1.8	1.8	550

2.2.7. Dvobrzinski motori s konstantnim momentom na obje brzine – DVA ODVOJENA NAMOTA
2.2.7. Two-speed motors with constant torque at both speed - TWO SEPARATE WINDINGS
2.2.7. Zweitourige Motoren mit konstantem Moment auf beiden Drehzahlen - ZWEI GETRENNTEN WICKLUNGEN
Tablica 2.29. / Table 2.29. / Tabelle 2.29.

2p=6/2		Y/Y	1000/3000 min ⁻¹
P (kW)			
2p=6	2p=2	Motor type	m (kg)
0.12	0.37	5AZP 80A-6/2	8.5
0.18	0.55	5AZP 80B-6/2	9.7
0.25	0.75	5AZP 90S-6/2	12.7
0.37	1.1	5AZP 90L-6/2	15.7
0.55	1.5	5AZP 100LA-6/2	21.8
0.75	2.2	5AZP 100LB-6/2	25
1	3	5AZP 112M-6/2	32.7
1.5	4.5	5AZP 132S-6/2	40
2	5.5	5AZP 132M-6/2	49
2.5	7.5	5AZP 160M-6/2	80
3.5	11	5AZP 160L-6/2	95
4	13.5	7AZP 180M-6/2	183
5	15	7AZP 180L-6/2	199
6	18.5	7AZP 180LA-6/2	225
6,5	20	7AZP 200L-6/2	250
8	25	7AZP 200LA-6/2	320
10	30	7AZP 225M-6/2	355
12	35	7AZP 250M-6/2	440
15	45	7AZP 280S-6/2	550
18,5	55	7AZP 280M-6/2	610

2p=8/2		Y/Y	750/3000 min ⁻¹
P (kW)			
2p=8	2p=2	Motor type	m (kg)
0.09	0.37	5AZP 80A-8/2	8.5
0.12	0.55	5AZP 80B-8/2	9.7
0.18	0.75	5AZP 90S-8/2	12.7
0.25	1.1	5AZP 90L-8/2	15.7
0.37	1.5	5AZP 100LA-8/2	22
0.55	2.2	5AZP 100LB-8/2	25
0.75	3	5AZP 112M-8/2	33
1.1	4.5	5AZP 132S-8/2	40
1.5	5.5	5AZP 132M-8/2	49
2.2	7.5	5AZP 160M-8/2	80
2.5	11	5AZP 160L-8/2	95
3	13.5	7AZP 180M-8/2	183
3.5	15	7AZP 180L-8/2	199
4	18.5	7AZP 180LA-8/2	225
4,5	20	7AZP 200L-8/2	250
5,5	25	7AZP 200LA-8/2	320
6,5	30	7AZP 225M-8/2	355
8,5	35	7AZP 250M-8/2	440
11	45	7AZP 280S-8/2	550
13	55	7AZP 280M-8/2	610

2.2.8. Izvedba motora s jednim namotom u Dahlander spoju
2.2.8. One winding in Dahlander connection
2.2.8. Motorausführung mit einer Wicklung in Dahlander-Schaltung
Tablica 2.30. / Table 2.30. / Tabelle 2.30.

Konstantni moment / Constant torque / Konstanten Moment			
2p=12/6		D/YY	500/1000 min ⁻¹
P (kW)			
2p=12	2p=6	Motor type	m (kg)
0.18	0.37	5AZP 90S-12/6	12.7
0.3	0.55	5AZP 90L-12/6	15.7
0.35	0.75	5AZP 100L-12/6	19.5
0.55	1.1	5AZP 112M-12/6	29
0.9	1.8	5AZP 132S-12/6	39
1.1	2.2	5AZP 132MA-12/6	45
1.5	3	5AZP 132MB-12/6	49
2.5	5	5AZP 160M-12/6	78
3.5	7	5AZP 160L-12/6	98
4.5	9	7AZP 180L-12/6	165
5.5	11	7AZP 180LA-12/6	220
5,5	11	7AZP 200L-12/6	245
6	12	7AZP 200LA-12/6	265
9,5	19,5	7AZP 225M-12/6	350
11,5	22,5	7AZP 250M-12/6	395
13,5	26,5	7AZP 280S-12/6	510
16	32	7AZP 280M-12/6	550

Ventilatorski pogon / Fan rated / Lufterantriebs Motoren			
2p=12/6		Y/YY	500/1000 min ⁻¹
P (kW)			
2p=12	2p=6	Motor type	m (kg)
0.1	0.55	5AZPV 90S-12/6	12.7
0.15	0.75	5AZPV 90L-12/6	15.7
0.22	1.1	5AZPV 100L-12/6	19.5
0.3	1.5	5AZPV 112M-12/6	29
0.5	2.5	5AZPV 132S-12/6	39
0.6	3	5AZPV 132MA-12/6	45
0.8	4	5AZPV 132MB-12/6	49
1	5	5AZPV 160M-12/6	78
1.5	7.5	5AZPV 160L-12/6	98
2.4	12	7AZPV 180L-12/6	165
3	15	7AZPV 180LA-12/6	220
3	15	7AZPV 200LA-12/6	245
3,5	16,5	7AZPV 200LB-12/6	265
5	25,5	7AZPV 225M-12/6	350
6	30	7AZPV 250M-12/6	395
7	35	7AZPV 280S-12/6	510
8.5	42,5	7AZPV 280M-12/6	550

2.2.9. Trobrzinski motori s konstantnim momentom - DVA ODVOJENA NAMOTA I DAHLANDER

2.2.9. Three-speed motors with constant torque - TWO SEPARATE WINDINGS AND DAHLANDER

2.2.9. Dreitourige Motoren mit konstantem Moment - ZWEI GETRENNTEN WICKLUNGEN UND DAHLANDER

Tablica 2.31. / Table 2.31. / Tabelle 2.31.

2p=8/4/2			750/1500/3000 min ⁻¹	
P (kW)			Motor type	m (kg)
2p=8	2p=4	2p=2		
0.18	0.45	0.55	5AZP 90S-8/4/2	12.7
0.25	0.7	1	5AZP 90L-8/4/2	15.7
0.37	1.1	1.3	5AZP 100LA-8/4/2	21.8
0.55	1.5	1.8	5AZP 100LB-8/4/2	25
0.7	2	2.4	5AZP 112M-8/4/2	32.7
1	2.6	3.2	5AZP 132S-8/4/2	40
1.5	3.6	4.5	5AZP 132M-8/4/2	49
2	4.5	6	5AZP 160M-8/4/2	80
2.7	6	8	5AZP 160L-8/4/2	95
3.7	7.5	10	7AZP 180M-8/4/2	183
5.5	9	12	7AZP 180L-8/4/2	199
6.5	11.5	15	7AZP 180LA-8/4/2	225
7	12	15.5	7AZP 200L-8/4/2	250
8.5	14	20	7AZP 200LA-8/4/2	320
10.5	17.5	23	7AZP 225M-8/4/2	355
13	21.5	30	7AZP 250M-8/4/2	440
17	28	37.5	7AZP 280S-8/4/2	550
20	34	45	7AZP 280M-8/4/2	610

2p=6/4/2			1000/1500/3000 min ⁻¹	
P (kW)			Motor type	m (kg)
2p=6	2p=4	2p=2		
0.3	0.45	0.55	5AZP 90S-6/4/2	12.7
0.45	0.7	1	5AZP 90L-6/4/2	15.7
0.7	1.1	1.3	5AZP 100LA-6/4/2	22
1	1.5	1.8	5AZP 100LB-6/4/2	25
1.5	2.2	2.4	5AZP 112M-6/4/2	33
1.8	2.6	3.2	5AZP 132S-6/4/2	40
2.4	3.6	4.3	5AZP 132M-6/4/2	49
3.4	4.5	6	5AZP 160M-6/4/2	80
4.5	6	8	5AZP 160L-6/4/2	95
6	7.5	10	7AZP 180M-6/4/2	183
7.5	9	12	7AZP 180L-6/4/2	199
9.5	11.5	15	7AZP 180LA-6/4/2	225
10	12	15.5	7AZP 200L-6/4/2	250
12	14	20	7AZP 200LA-6/4/2	320
14.5	17.5	23	7AZP 225M-6/4/2	355
18	21.5	30	7AZP 250M-6/4/2	440
23	28	37.5	7AZP 280S-6/4/2	550
28	34	45	7AZP 280M-6/4/2	610

Tablica 2.32. / Table 2.32. / Tabelle 2.32.

2p=8/6/4			750/1000/1500 min ⁻¹	
P (kW)			Motor type	m (kg)
2p=8	2p=6	2p=4		
0.2	0.3	0.37	5AZP 90S-8/6/4	12.7
0.25	0.37	0.55	5AZP 90L-8/6/4	15.7
0.32	0.45	0.6	5AZP 100LA-8/6/4	21.8
0.45	0.6	0.8	5AZP 100LB-8/6/4	25
0.8	1.1	1.5	5AZP 112M-8/6/4	32.7
1.1	1.5	2.2	5AZP 132S-8/6/4	40
1.9	2.5	3.8	5AZP 132M-8/6/4	49
2.5	3.3	4.5	5AZP 160M-8/6/4	80
4	5	6	5AZP 160L-8/6/4	95
5.5	7	9	7AZP 180M-8/6/4	183
7	9	11	7AZP 180L-8/6/4	199
8.5	11.5	13.5	7AZP 180LA-8/6/4	225
9	12	14.5	7AZP 200L-8/6/4	250
11	14	17.5	7AZP 200LA-8/6/4	320
13.5	17	21	7AZP 225M-8/6/4	355
16.5	21.5	26.5	7AZP 250M-8/6/4	440
22	28.5	35	7AZP 280S-8/6/4	550
26.5	34	41.5	7AZP 280M-8/6/4	610

**2.2.10. Trobrzinski motori
za pogon ventilatora –
DVA ODVOJENA NAMOTA i
DAHLANDER**
**2.2.10. Three-speed fan rated
motors - TWO SEPARATE
WINDINGS AND DAHLANDER**
**2.2.10. Dreitourige
Lüfterantriebsmotoren - ZWEI
GETRENNTEN WICKLUNGEN
UND DAHLANDER**
Tablica 2.33. / Table 2.33. / Tabelle 2.33.

2p=8/4/2			750/1500/3000 min ⁻¹		2p=6/4/2			1000/1500/3000 min ⁻¹	
P (kW)			Motor type	m (kg)	P (kW)			Motor type	m (kg)
2p=8	2p=4	2p=2			2p=6	2p=4	2p=2		
0,06	0,15	0,75	5AZPV 90S-8/4/2	12,7	0,08	0,15	0,75	5AZPV 90S-6/4/2	12,7
0,08	0,25	1	5AZPV 90L-8/4/2	15,7	0,1	0,25	1	5AZPV 90L-6/4/2	15,7
0,15	0,4	1,5	5AZPV 100LA-8/4/2	22	0,2	0,4	1,5	5AZPV 100LA-6/4/2	22
0,2	0,5	2	5AZPV 100LB-8/4/2	25	0,3	0,5	2	5AZPV 100LB-6/4/2	25
0,25	0,65	2,7	5AZPV 112M-8/4/2	33	0,35	0,65	2,7	5AZPV 112M-6/4/2	33
0,3	0,85	3,4	5AZPV 132S-8/4/2	40	0,4	0,85	3,4	5AZPV 132S-6/4/2	40
0,4	1,2	4,8	5AZPV 132M-8/4/2	49	0,55	1,2	4,8	5AZPV 132M-6/4/2	49
0,55	1,75	7	5AZPV 160M-8/4/2	80	0,9	1,9	7,5	5AZPV 160M-6/4/2	80
0,8	2,25	9	5AZPV 160L-8/4/2	95	1,2	2,25	9	5AZPV 160L-6/4/2	95
1,2	3	12	7AZPV 180M-8/4/2	183	1,5	3	12	7AZPV 180M-6/4/2	183
1,5	3,75	15	7AZPV 180L-8/4/2	199	2,2	3,75	15	7AZPV 180L-6/4/2	199
1,85	4,5	18,5	7AZPV 180LA-8/4/2	225	3	4,5	18,5	7AZPV 180LA-6/4/2	225
2	5	20	7AZPV 200L-8/4/2	250	3	5	20	7AZPV 200L-6/4/2	250
2,5	6	24	7AZPV 200LA-8/4/2	320	3,5	6	24	7AZPV 200LA-6/4/2	320
3	7,5	29	7AZPV 225M-8/4/2	355	4,5	7,5	29	7AZPV 225M-6/4/2	355
3,5	9	36	7AZPV 250M-8/4/2	440	5,5	9	36	7AZPV 250M-6/4/2	440
4,5	12	47,5	7AZPV 280S-8/4/2	550	7	12	47,5	7AZPV 280S-6/4/2	550
6	14	55	7AZPV 280M-8/4/2	610	8,5	14	55	7AZPV 280M-6/4/2	610

Tablica 2.34. / Table 2.34. / Tabelle 2.34.

2p=8/6/4			750/1000/1500 min ⁻¹	
P (kW)			Motor type	m (kg)
2p=8	2p=6	2p=4		
0,09	0,15	0,37	5AZPV 80A-8/6/4	8,5
0,12	0,22	0,55	5AZPV 80B-8/6/4	9,7
0,18	0,3	0,75	5AZPV 90S-8/6/4	12,7
0,25	0,4	1,1	5AZPV 90L-8/6/4	15,7
0,37	0,55	1,5	5AZPV 100LA-8/6/4	22
0,45	0,7	1,8	5AZPV 100LB-8/6/4	25
0,6	0,85	2,4	5AZPV 112M-8/6/4	33
0,75	1,1	3	5AZPV 132S-8/6/4	40
1,1	1,5	4,4	5AZPV 132M-8/6/4	49
1,5	2,2	6	5AZPV 160M-8/6/4	80
2,2	3,1	8,8	5AZPV 160L-8/6/4	95
2,8	4,5	11,2	7AZPV180M-8/6/4	183
3,5	5,5	14	7AZPV 180L-8/6/4	199
4,5	6,5	17,5	7AZPV 180LA-8/6/4	225
5	7	18,5	7AZPV 200L-8/6/4	250
5,5	9	22	7AZPV 200LA-8/6/4	320
6,5	10,5	27	7AZPV 225M-8/6/4	355
8,5	13	33	7AZPV 250M-8/6/4	440
11	17,5	45	7AZPV 280S-8/6/4	550
13	20,5	52,5	7AZPV 280M-8/6/4	610

2.3 Motori brodske izvedbe

Prisutnost društva KONČAR-MES u brodogradnji je dugogodišnja. Veliko proizvodno iskustvo i kvaliteta proizvoda podvrgnutih najrigoroznijim testovima kod proizvođača i uz prisutnost predstavnika klasifikacijskih registara, garancija su pouzdanosti u teškim uvjetima upotrebe na brodovima ili instalacijama na ili uz more, te potvrda pravilnog odabira prilikom definiranja ugradbene opreme bilo od specijaliziranih inženjerskih kuća, bilo direktno od strane brodograditelja. Asinkroni kavezni motori u brodskoj izvedbi mogu se koristiti kao pomoćni pogoni na palubi i u potpalublju broda i u industrijskim pogonima na obali. Temperaturno opterećenje motora je prilagođeno općenito višim temperaturama okoline na brodu.

Klasifikacijska tijela dijele pogone na brodu u dvije grupe: „ključni pogoni“ i „ne-ključni pogoni“. Ispitivanje prihvatljivosti od strane relevantnog klasifikacijskog tijela se zahtjeva za motore korištene u ključnim pogonima, ovisno o njihovoj izlaznoj snazi. U posebnim slučajevima, kao dodatak ispitivanju prihvatljivosti, može se zahtijevati i nadzor izrade motora. Nadzor izrade uključuje promatranje pojedinih stupnjeva proizvodnje motora od strane inspektora nadležnog klasifikacijskog tijela. Troškovi klasifikacijskog tijela za ispitivanja prihvatljivosti i ispitivanja prihvatljivosti s nadzorom izrade se posebno naplaćuju.

Asinkroni kavezni motori za brodarstvo su tipno odobreni od klasifikacijskih društava HRB (CRS) Hrvatski registar brodova (Hrvatska) i BV Bureau Veritas (Francuska).

Motore u brodskoj izvedbi radimo i prema zahtjevima drugih klasifikacijskih društava, ali bez tipskog odobrenja, kao što su: GL Germanischer Lloyd (Njemačka), LRS Lloyd Register of Shipping (Velika Britanija), DNV Det Norske Veritas (Norveška), ABS American Bureau of Shipping, RMRS Russian Maritime Register of Shipping (Rusija), CCS Chinese Classification Society (China) i KR Koreanski registar.

Proizvodnja i sustav osiguranja kvalitete elektromotora za brodarstvo je pod trajnim nadzorom klasifikacijskog društva BV.

Za naše elektromotore posjedujemo certifikat o primjeni BV MODE I Survey Scheme u sklopu kojega osiguranje kvalitete Društva u ime BV vrši nadzor proizvodnje, kontrolu i ispitivanje, označavanje proizvoda i izdavanje potvrde o sukladnosti proizvoda, CERTIFICATE OF PRODUCT CONFORMITY.

Prema kategoriji smještaja dijele se na Kategoriju smještaja I (rad na palubi) za pogon

2.3 Marine design motors

KONČAR-MES has a long-term presence in ship building industry. Great experience in production and quality of product tested at the most rigorous manner at manufacturers equipment in the presence of Classification register representative, are guarantee that KONČAR-MES motors are reliable for the use in hard conditions on ships or installations at/or by the sea, and confirmation of right choice when defining equipment to be built in by engineering houses or ship-owner by himself. Marine design induction motors can be used an auxiliary drive on upper deck or below deck and industrial equipment on the shore. Thermal motor load is adjusted to the higher ambient temperatures on board.

Classification bodies are dividing ship drives in two groups: „Essential drives“ and „Non-essential drives“. Survey from relevant classification body is requested for motors to be used in essential drives, depending on motor output power. In special cases, besides testing of acceptance, surveillance over motor production may be requested. Production surveillance includes monitoring of certain production processes by the surveyor of competent classification body. Costs of surveying body for acceptance testing and acceptance testings with survey of manufacturing are charged separately.

Marine designed induction motors have type approval from following classification societies: HRB (CRS) – Croatian Registry of Shipping (Croatia) and BV - Bureau Veritas (France).

Marine designed motors can also be produced in accordance with requests of other classification societies, but without type approval, such as: GL – Germanischer Lloyds (Germany), LRS – Lloyd's Register of Shipping (Great Britain), DNV – Det Norske Veritas (Norway), ABS – American Bureau of Shipping (USA), RMRS – Russian Maritime Register of Shipping (Russia), CCS – Chinese Classification Society and KR Korean Registry of Shipping.

Production and quality system of marine designed electric motors is under permanent survey of classification societie BV.

For our electric motors we have certificate BV MODE I Survey Scheme according to which the QA Department of KONČAR-MES performs surveillance over production, control and testing, marking of products and issuing manufacturer's declaration of conformity (CERTIFICATE OF PRODUCT CONFORMITY) on behalf of BV. According to the location, motors are divided to the following: Location category I (operation on upper deck) for crane drives, anchor and mooring winch drives etc. (usually manufactured in IP56 protection index);

2.3 Motoren in schiffs-ausführung

Die Gesellschaft KONČAR-MES hat eine langjährige Präsenz im Schiffsbau. Reiche Erfahrung in Herstellung und die Qualität der Produkte, die vom Hersteller den strengsten Prüfungen unter Anwesenheit der Vertreter der Klassifizierungsgesellschaften unterworfen werden, sind Garantie für Verlässlichkeit in schweren Einsatzbedingungen auf Schiffen oder Installationen auf dem Meer oder auf der Küste und Bestätigung richtiger Wahl der Einbauteile, entweder seitens spezialisierter Ingenieurhäuser oder seitens der Schiffswerft. Die Asynchronmotoren in Schiffsausführung können als Hilfsantriebe am Schiffsdeck oder unter dem Schiffsdeck sowie in den Küstenindustriebetrieben eingesetzt werden. Die Temperaturbelastung der Motoren ist allgemein höheren Umgebungstemperaturen auf den Schiffen angepasst.

Die Klassifizierungsgesellschaften teilen die Hilfsantriebe auf den Schiffen in zwei Gruppenein: „betriebswichtige“ und „nichtbetriebswichtige“ Antriebe. Die Begutachtung relevanter Klassifikationsgesellschaften wird für die Motoren, die in betriebswichtigen Antrieben verwendet werden, abhängig von derer Ausgangsleistung, verlangt. In Sonderfällen als Zusatz der Begutachtung kann man auch die Aufsicht der Motorherstellung verlangen. Die Aufsicht schließt die Beobachtung einzelner Motorherstellungsstufen seitens Beaufachter zuständiger Klassifizierungsgesellschaften ein. Die Gebühren der Klassifikationsgesellschaften für Begutachtungen bzw. Begutachtungen mit Bauaufsicht werden gesondert verrechnet.

Die Asynchronmotoren mit Käfigläufer für Schiffe wurden von folgenden Klassifizierungsgesellschaften genehmigt: HRB (CRS) – Croatian Registry of Shipping (Kroatien) und BV - Bureau Veritas (Frankreich).

Die Motoren in Schiffsausführung fertigen wir auch nach Anforderungen anderer Klassifikationsgesellschaften, jedoch ohne Typenbescheinigung, wie: GL – Germanischer Lloyds (Deutschland), LRS – Lloyd's Register of Shipping (Grossbritannien), DNV – Det Norske Veritas (Norwegen), ABS – American Bureau of Shipping (USA), RMRS – Russian Maritime Register of Shipping (Russland), CCS – Chinese Classification Society (China) und KR-Korean Register of Shipping (Südkorea).

Produktion und Qualitätssicherungssystem der Motoren für Schiffe steht unter dauerhafter Aufsicht der Klassifizierungsgesellschaften BV. Für unsere Motoren das Zertifikat über

dizalica, kranova, sidrenih i priteznih vitala i slično (najčešće se izvode u stupnju zaštite IP 56) i Kategoriju smještaja II (rad u potpalublju) za pogone crpki, ventilatora, kompresora i slično (najčešće se izvode u stupnju zaštite IP54/55). U ovisnosti od stupnja zaštite motori su sposobni za rad trajno ili povremeno izloženi zapljuskivanju morske vode ili u klimi zasićenoj slanom maglom, odnosno u tropskoj klimi.

Izolacijski sustav je toplinske klase F s graničnom temperaturom namota (dopuštenim zagrijavanjem) prema IEC 92-301 i nacionalnim registrima brodova. Namot motora u brodske izvedbi izrađuje se lak žicom s dvostrukim prirastom laka u toplinskoj klasi H. Namoti motora nakon impregnacije zaštićuju se antifungicidnim lakom.

Motori mogu biti opremljeni i sa sigurnosnom kočnicom i ostalim mogućnostima koje su navedene u opisu pojedine serije. Također, u ovisnosti o seriji, motori mogu biti opremljeni s antikondenzacijskim grijačima namota ako postoji mogućnost da budu izloženi stvaranju kondenzata.

Završni premazi su izvedeni za svjetske klime prema DIN IEC 60 721-2-1 i nude visoku zaštitu od korozije osobito pogodnu za ugradnju motora u slana korozivna ozračja i u prostore sa stalnom povišenom vlažnošću.

Tipske oznake za upotrebu na brodovima certificiranih serija motora KONČAR-MES dane su u tablici 1.32.

and Location category II (below deck operation) for pump drives, fan drives, compressor drives etc. (usually manufactured in IP54/55 protection index). Depending on protection index, motors may be operated permanently or periodically exposed to sea water splashes or in climate with saturated salted fog, in other words – in tropical climate.

Insulation system is in thermal class F with adjacent winding temperature (permissible rise) according to IEC 92-301 and national register of shipping. Winding of marine design motors is made of enamelled wire with double increase of insulation varnish in thermal class H. Motor windings are additionally protected by nonfungicide varnish after impregnation.

Motors can be equipped a safety brake and other options mentioned in description of particular series. Depending on motor series, motors can be equipped with anticondensation heaters of stator windings as well, if there is possibility of exposure to condensation.

Final coating is made for world climates according to DIN IEC 60 721-2-1 and brings high corrosion protection especially for motors to be built in salted corrosive environment and places with permanent high humidity.

Type designation marks of electric motors to be used on ships (marine designed) produced by KONČAR-MES are given in the Table 1.32.

Verwendung der BV MODE und Survey Scheme, das die Qualitätssicherung der Gesellschaft in Namen von BV, die Produktionsaufsicht, Kontrolle und Prüfung, sowie die Produktbezeichnung und Ausgabe der Produktkonformitätserklärung (CERTIFICATE OF PRODUCT CONFORMITY) miteinschließt.

Gemäß Aufstellungskategorien werden die Motoren in Aufstellungskategorie I (Arbeit auf dem Deck) für den Antrieb von Hebezügen, Kränen, Anker- u. Aufziehwinden u.ä. (meistens ausgeführt in mechanischer Schutzart IP56) und in Aufstellungskategorie II (Arbeit unter dem Deck) für die Antriebe der Pumpen, Ventilatoren, Kompressoren u.ä. (meistens ausgeführt in mechanischer Schutzart IP 54/55) eingeteilt. Abhängig von der Schutzart können die Motoren während des Betriebs dauerhaft oder zeitweilig dem Seewasser ausgesetzt sein, oder in Klimabedingungen gesättigt mit dem Salznebel bzw. im tropischen Klima betrieben werden.

Isolationssystem entspricht der Wärmeklasse F mit der Wicklungsgrenztemperatur (zusätzliche Erwärmung) nach IEC 92-301 und dem nationalen Schiffsregister. Die Motorwicklung in Schiffausführung wird mit Lackdraht mit doppelter Isolierung in Wärmeklasse Hausgeführt. Die Wicklungen werden nach der Impregnierung mit antifungizidem Lack geschützt.

Die Motoren können auch mit Sicherheitsbremse und mit anderen Optionen, die in der Beschreibung einzelner Baureihen angeführt sind, ausgerüstet sein. Weiterhin, abhängig der Baureihe können die Motoren mit der Stillstandsheizung der Wicklung ausgerüstet sein, wenn die Möglichkeit besteht, dass sie der Kondensbildung ausgesetzt werden können.

Endanstriche sind ausgeführt für die Weltweitklimen gemäß DIN IEC 60 721-2-1 und bieten hohen Korrosionsschutz, besonders geeignet für die Motoraufstellung in salziger Korrosionsumgebungen und Räumen mit ständig erhöhter Feuchtigkeit.

Typenbezeichnungen für den Einsatz auf Schiffen zertifizierter Motorenbaureihen von KONČAR-MES sind in der Tabelle 1.32. gegeben.

Tablica 2.35. / Table 2.35. / Tabelle 2.35.

Norme: IEC / DIN / VDE i propisi klasifikacijskih društava	Standards: IEC / DN / VDE and directives of clasification societies	Normen: IEC / DN / VDE und Vorschriften der Klassifizierungsgesellschaften
Tipske oznake Serija 5ABZ 63 – 160 Serija 5ABZK 63 – 160 Serija 7ABZ 90 – 315 Serija 7ABZK 90 – 315	Type designations: Series 5ABZ 63 – 160 Series 5ABZK 63 – 160 Series 7ABZ 90 – 315 Series 7ABZK 90 – 315	Typenbezeichnungen: Baureihe 5ABZ 63 – 160 Baureihe 5ABZK 63 – 160 Baureihe 7ABZ 90 – 315 Baureihe 7ABZK 90 – 315
Napon i frekvencija: 400 V (Y do 2,2 kW, Δ od 3 kW); 50Hz 440 V (Y do 2,2 kW, Δ od 3 kW); 60Hz	Voltage and frequency: 400 V (Y up to 2,2 kW, Δ from 3 kW); 50Hz 440 V (Y up to 2,2 kW, Δ from 3 kW); 60Hz	Spannung u.Freqüenz: 400 V (Y bis 2,2 kW, Δ ab 3 kW); 50Hz 440 V (Y bis 2,2 kW, Δ ab 3 kW); 60Hz
Klasa izolacije: F (zagrijavanje u B)	Insulation class: F (rise in B)	Isolationsklasse: F (Erwärmung im B)
Ton boje: RAL 7031 (poliuretanska boja)	Colour tone: RAL 7031 (polyurethane paint)	Farbton: RAL 7031 (Poliurethanlack)
Ostalo: Dodatno pojašnjenje serije prema KATALOŠKIM STRANICAMA odgovarajuće osnovne grupe proizvoda KONČAR-MES	Other: See additional explanation of series according to CATALOGUE PAGES of equivalent basic group of KONČAR-MES products	Sonstiges: Zusätzliche Erklärung der Baureihen auf den KATALOGSEITEN der jeweiligen Grundproduktgruppe von KONČAR-MES

HRB/CRS - BV - DNV-GL - LR - RINA - RS - RRR - CCS - KR - ABS - IR - NKK



2.4. Ostale mogućnosti (dodatne izvedbe motora i prigrađivanja na motor)

2.4. Other options (additional motor arrangements and mounting designs)

2.4. Andere Optionen (weitere Motorausführungen - und Anbauten)

Tablica 2.36. / Table 2.36. / Tabelle 2.36.

Mogućnosti	Options	Optionen
drugi naponi (ili višenaponski) i frekvencije	<i>other voltages (or multivoltages) and frequencies</i>	andere Spannungen (oder Mehrspannungsbereich) und Frequenzen
drugi broj pari polova za jedno i višebrzinski motori	<i>different pole numbers for single and multi-speed motors</i>	anderen Polzahlen für ein- u. mehrtourige Motoren
drugi oblici ugradnje	<i>other mounting arrangements</i>	andere Bauformen
termička zaštita (PTC sonde ili termoprekidači ili PT100)	<i>thermal protection (PTC thermistors or thermal switches or PT100)</i>	thermischer Schutz (PTC Kaltleiter oder ThermoSchalter oder PT100)
dva izlazna kraja vratila (na PS i SS)	<i>two shaft free ends (on DE and on NDE)</i>	zwei Wellenenden (auf AS und BS)
izolacija za temperaturnu klasu "H"	<i>„H“ insulation class</i>	Isolation für Wärmeklasse „H“
posebne prirubnice i krajevi vratila	<i>special flanges and shaft ends</i>	Sonderflanschen – u. Wellenenden
izvedba s ormarićem desno ili lijevo	<i>terminal box on right or left side</i>	Ausführung mit dem Klemmenkasten rechts oder links
ostali tonovi boje i /ili vrste naliča i/ili specijalni kemijski otporni naliči	<i>other colour tones and/or surface paints and/or special chemical resistant surface paints</i>	andere Farbtöne und/oder Anstricharten und/oder chemisch beständige Oberflächensonderanstriche
Ventilatorska kapa sa zaštitom od padalina ili lebdećih tekstilnih vlakana	<i>Fan cover with protection from rainfall and textile fibre</i>	Lufterhaube mit dem Regenschutzdach oder Textilhaube
Drugi oblici hlađenja (IC410, IC416, IC418)	<i>Cooling types (IC410, IC416, IC418)</i>	Kühlungstypen (IC410, IC416, IC418)
namot za tropske uvjete	<i>winding for tropical environment</i>	Tropenwicklung
grijači namota	<i>winding heaters</i>	Wicklungsheizung
Rupe za ispust kondenzata	<i>Consensation drain holes</i>	Kondensablasslöcher
valjkasti ležajevi	<i>roller bearings</i>	Rollenlager
mazalice	<i>regreasing facility</i>	Nachschmiereinrichtungen mit Schmiernippel
SPM sonde u ležajnim štitovima	<i>SPM nipple in bearing shields</i>	SPM-Nippel auf den Lagerschilder
brodska izvedba	<i>marine design</i>	Marinenausführung
stupanj zaštite do IP65/66	<i>protection index up to IP65/66</i>	Schutzgrad bis IP65/66
ostale vrste pogona S2-S10	<i>other duty types S2 – S10</i>	andere Betriebsarten S2 – S10
pogon preko pretvarača	<i>driven by through frequency inverter</i>	Frequenzumformerbetrieb
i ostale izvedbe prema želji kupca	<i>and other customer demand based design</i>	und andere kundenspezifische Ausführungen
prigrađeno na motor	<i>built-in</i>	auf den Motor angebaut
priključni kabel, grebenasta sklopka	<i>connecting cable, drum type switch</i>	Anschlusskabel, Nockenschalter
motorska zaštitna sklopka	<i>motor protective switch</i>	Motorschutzschalter
strana ventilacija (način hlađenja IC 416)	<i>forced ventilation (cooling type IC 416)</i>	Fremdlüfter (Kühlungsart IC 416)
sigurnosna el.magnetska kočnica	<i>fail-safe spring loaded electromagnetic brake</i>	elektromagnetische Sicherheitsbremse
enkoder	<i>encoder</i>	Drehimpulsgeber
tahogenerator	<i>tachogenerator</i>	Tachogenerator
resolver	<i>resolver</i>	Resolver
ostali senzori praćenja veličina	<i>other sensors and monitoring devices</i>	andere Sensoren der Größenüberwachung
i ostale izvedbe prema želji kupca	<i>and other customer demand based design</i>	und andere kundenspezifische Ausführungen





IEC veličina

56 – 160 (5AZ serija)

112 – 315 (7AZ serija)

Popis rezervnih dijelova s uputom za naručivanje nalazi se u poglavlju 7. Rezervni dijelovi.

Svi navedeni tehnički podaci su informativni te za njih proizvođač Končar-MES pridržava pravo promjene bez prethodne najave.

IEC frame size

56 – 160 (5AZ series)

112 – 315 (7AZ series)

Spare part list with ordering instructions is given in chapter 7. Spare parts.

All technical data are informative and manufacturer Končar-MES reserves right to their change without prior notice.

IEC Baugröße

56 – 160 (5AZ Baureihe)

112 – 315 (7AZ Baureihe)

Die Liste der Ersatzteile und Bestellungsanweisung befinden sich im Kapitel 7. – Ersatzteile.

Alle technischen Daten sind informativ und der Hersteller Končar-MES behält das Änderungsrecht ohne Vorankündigung.

2.5. Mjerne skice

Serijs 5AZ i 7AZ
Motori s nogama

2.5. Dimensional drawing

Series 5AZ and 7AZ
Motors with mounted feet

2.5. Masszeichnungen

Baureihen 5AZ und 7AZ
Fußmotoren

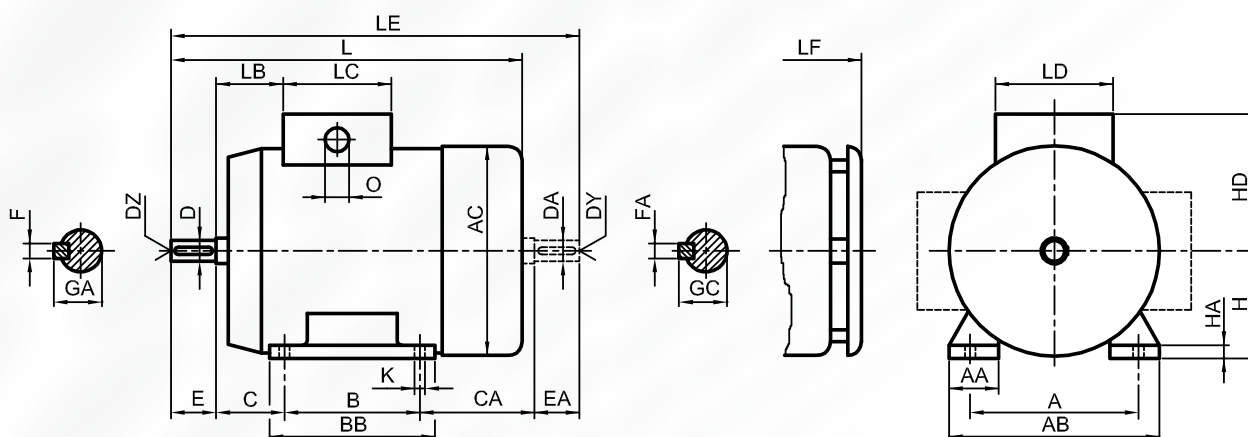

Tablica 2.37. / Table 2.37. / Tabelle 2.37.

Tipaska oznaka	AC	D / DA	DZ / DY	E / EA	F / FA	GA / GC	HD	L	LB	LC	LD	LE	LF	O	IM B3									
															A	AA	AB	B	B1	BB	C	H	HA	K
5AZ 56	110	9j6	M3	20	3	10	96	190	24	75	75	215	205		90	22	108	71	-	90	36	56	7	6x11
5AZ 63	123	11j6	M4	23	4	13	102	215	26	75	75	240	230		100	23	120	80	-	105	40	63	10	7x12
5AZ 71	139	14j6	M5	30	5	16	110	245	37	75	75	278	260		112	26	137	90	-	109	45	71	12	8x12
5AZ 80	156	19j6	M6	40	6	21,5	126	270	33	90	90	315	285		125	36	160	100	-	125	50	80	11	8x16
5AZ 90S	176	24j6	M8	50	8	27	132	300	37	90	90	355	317		140	35	175	100	-	130	56	90	13	9x16
5AZ 90L	176	24j6	M8	50	8	27	132	325	37	90	90	380	342		140	35	175	125	-	155	56	90	13	9x16
5AZ 90LX	176	24j6	M8	50	8	27	132	383	37	90	90	420	380		140	35	175	125	-	155	56	90	13	9x16
5AZ 100L	194	28j6	M10	60	8	31	140	365	44	90	90	430	385		160	37	195	140	-	175	63	100	12	11x22
5AZ 100LX	194	28j6	M10	60	8	31	140	405	44	90	90	470	425		160	37	195	140	-	175	63	100	12	11x22
5AZ 112M	218	28j6	M10	60	8	31	151	385	46	90	90	450	405		190	40	225	140	-	177	70	112	14	12x21
5AZ 112MX	218	28j6	M10	60	8	31	151	420	46	90	90	485	440		190	40	225	140	-	177	70	112	14	12x21
5AZ 132S	257	38k6	M12	80	10	41	186 (200)	477	57,5 (51)	112 (125)	112 (125)	562	507		216	44	260	140	-	180	89	132	18	12x22
5AZ 132M	257	38k6	M12	80	10	41	186 (200)	515	57,5 (51)	112 (125)	112 (125)	600	545		216	44	260	178	-	218	89	132	18	12x22
5AZ 160M	318	42k6	M16	110	12	45	225 (245)	515	76 (52)	142 (186)	142 (186)	713	623		254	64	318	210	-	260	108	160	20	14x24
5AZ 160L	318	42k6	M16	110	12	45	225 (245)	661	76 (52)	142 (186)	142 (186)	757	667		254	64	318	254	-	304	108	160	20	14x24
7AZ 90	176	24j6	M8	50	8	27	173	366	28	135	135	421	386		140	35	180	125	-	155	56	90	12	10
7AZ 100MX	194	28j6	M10	60	8	31	183	430	29	135	135	504	459		160	40	200	140	-	175	63	100	13	13
7AZ 112MX	218	28j6	M10	60	8	31	193	448	27	135	135	511	465		190	40	220	140	-	175	70	112	15	13
7AZ 132S & M	257	38k6	M12	80	10	41	236	515	44	170	170	600	545		216	50	260	140	178	218	89	132	18	13
7AZ 132MX	257	38k6	M12	80	10	41	236	565	44	170	170	650	595		216	50	260	178	-	218	89	132	18	13
7AZ 160M & L	318	42k6	M16	110	12	45	288	657	47	210	210	757	667		254	62	320	210	254	304	108	160	25	15x20
7AZ 180M & L	348	48k6	M16	110	14	51,5	306	705	61,5	210	210	818	735		279	65	350	241	279	334	121	180	28	15x22
7AZ 200	391	55m6	M20	110	16	59	328	793	63	250	250	903	880		318	75	398	305	-	368	133	200	30	19x27
7AZ 225S & M-2	425	55m6	M20	110	16	59	346	840	65	250	250	950	930		356	82	436	286	311	370	149	225	30	19x27
7AZ 225S & M -4, -6	425	60m6	M20	140	18	64	346	870	65	250	250	1010	960		356	82	436	286	311	370	149	225	30	19x27
7AZ 250M-2	471	60m6	M20	140	18	64	369	915	64	280	280	1055	1010		406	100	500	349	-	415	168	250	35	24x30
7AZ 250M -4, -6	471	65m6	M20	140	18	69	369	915	64	280	280	1055	1010		406	100	500	349	-	415	168	250	35	24x30
7AZ 280S & M-2	533	65m6	M20	140	18	69	419	1043	82,5	280	280	1185	1150		457	112	555	368	419	533	190	280	40	24
7AZ 280S & M -4, -6	533	75m6	M20	140	20	79,5	419	1043	82,5	280	280	1185	1150		457	112	555	368	419	533	190	280	40	24
7AZ 315S & M-2	611	65m6	M20	140	18	69	468	1270	87	310	310	1410	1380		508	120	628	406	457	586	216	315	45	28
7AZ 315S & M -4, -6	611	80m6	M20	170	22	85	468	1300	87	310	310	1470	1410		508	120	628	406	457	586	216	315	45	28
7AZ 315L-2	611	65m6	M20	140	18	69	468	1270	87	310	310	1410	1380		508	120	628	508	-	586	216	315	45	28
7AZ 315L-4, -6	611	80m6	M20	170	22	85	468	1300	87	310	310	1470	1410		508	120	628	508	-	586	216	315	45	28
7AZ 315LX-2	611	65m6	M20	140	18	69	468	1350	87	310	310	1490	1460		508	120	628	508	-	586	216	315	45	28
7AZ 315LX-4, -6	611	80m6	M20	170	22	85	468	1380	87	310	310	1550	1490		508	120	628	508	-	586	216	315	45	28

Table 1.20.

Serija 5AZ i 7AZ
Motori s priрубnicom

Series 5AZ and 7AZ
Flange mounted motors

Baureihen 5AZ und 7AZ
Flanschmotoren

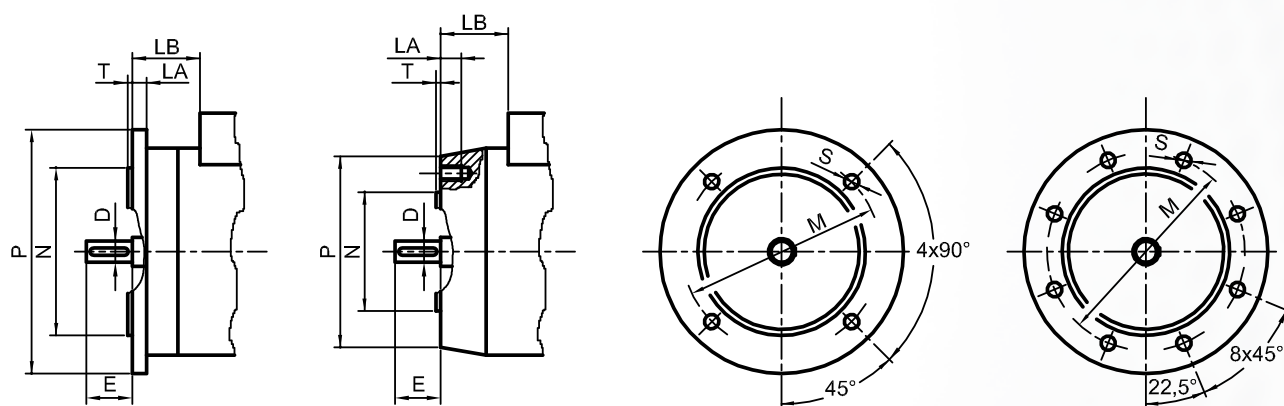

Tablica 2.38. / Table 2.38. / Tabelle 2.38.

Tipaska Oznaka	IM B5						IM B14 - manja/small						IM B14 - veća/large					
	LA	M	N	P	S	T	LA	M	N	P	S	T	LA	M	N	P	S	T
5AZ 56	8	100	80j6	120	7	3	8	65	50j6	80	M5	3						
5AZ 63	9	115	95j6	140	9,5	3	8	75	60j6	90	M5	3						
5AZ 71	10	130	110j6	160	9,5	3	8	85	70j6	105	M6	2,5	10	115	95j6	140	M8	3
5AZ 80	10	165	130j6	200	11,5	3,5	8	100	80j6	120	M6	3	10	130	110j6	160	M8	3,5
5AZ 90	10	165	130j6	200	12	3,5	10	115	95j6	140	M8	3	10	130	110j6	160	M8	3,5
5AZ 100	15	215	180j6	250	15	4	10	130	110j6	160	M8	3	12	165	130j6	200	M10	3,5
5AZ 112	15	215	180j6	250	15	4	10	130	110j6	160	M8	3	12	165	130j6	200	M10	3,5
5/7AZ 132	15	265	230j6	300	14	4	16	215	180j6	250	M12	4						
5/7AZ 160	20	300	250j6	350	18	5												
7AZ 90	13	165	130j6	200	11	3,5	13	115	95j6	140	M8	3,5	13	130	110j6	160	M8	3,5
7AZ 100	15	215	180j6	250	15	4	15	130	110j6	160	M8	3,5	15	165	130j6	200	M10	3,5
7AZ 112	15	215	180j6	250	15	4	15	130	110j6	160	M8	3,5	15	165	130j6	200	M10	3,5
7AZ 180	20	300	250j6	350	18	5												
7AZ 200	20	350	300j6	400	19	5												
7AZ 225	22	400	350j6	450	19	5												
7AZ 250	22	500	450j6	550	19	5												
7AZ 280	22	500	450j6	550	19	5												
7AZ 315	25	600	550j6	660	24	6												

03

JEDNOFAZNI MOTORI SINGLE-PHASE INDUCTION MOTORS EINPHASIGE ASYNCHRONMOTOREN



3.1. Općenito

Naši jednofazni asinkroni kavezni motori potpuno zatvorene izvedbe i hlađeni vlastitim ventilatorom (IC 411) prikladni su za različite primjene kao što su ventilacija, isporuka stlačenog zraka, crpljenje tekućina, poljoprivreda i prehrambena industrija, mali proizvodni pogoni, kućanstva itd.

Odlikuju se visokom kakvoćom upotrebljenih materijala, ležajevima podmazanim za vijek trajanja, završnim naličjem otpornim na utjecaje vremena i koroziju, izdržljivim izolacijskim sustavom te niskim operativnim troškovima.

Jednofazni asinkroni motori s kondenzatorom za trajni rad serije 5AZC vrlo su prikladni za veliki broj pogona, posebice onih s laganim zaletom, s obzirom da se veliki broj pogona pokreće neopterećen ili s vrlo malim opterećenjem. Posebno su prikladni za pogone ventilatora, kružnih pila, brusilica, centrifugalnih pumpi, raznih mlinova, bušilica i sl.

Jednofazni asinkroni motori s pogonskim i zaletnim kondenzatorom 5AZCD (motori s povećanim poteznim momentom) nalaze primjenu u pogonima s teškim uvjetima rada. Posebice su prikladni za pogone kompresora, raznih preša, mlinova, strojeva za vršenje i ostalih teških poljoprivrednih strojeva. Zaletni kondenzator uključen je za vrijeme zaleta paralelno s pogonskim kondenzatorom, a isključuje ga centrifugalna sklopka kad motor postigne cca 80% nazivne brzine vrtnje.

Priključna kutija jednofaznih motora u osnovnoj izvedbi izrađena je od plastične mase, a pored priključne pločice u kutiju su smješteni i kondenzatori. Kutija je opremljena kabelskom uvodnicom za uvod priključnog kabela.

Kondenzatori. Motori serije 5AZC, opremljeni su kondenzatorima za trajni rad nazivnih napona i kapaciteta naznačenih u tablicama Tehnički podaci. Motori serije 5AZCD (motori s povećanim poteznim momentom) pored kondenzatora za trajni rad opremljeni su i elektrolitskim kondenzatorom za zalet s nazivnim veličinama navedenim u tablicama Tehnički podaci.

Nazivne vrijednosti svih kondenzatora navedenih u tablicama vrijede za mrežu nazivnog napona 230V. Sve to daje Vam dodatno povjerenje da će Vaši ventilatori, crpke, kompresori ili neki drugi radni strojevi biti prikladno opremljeni motorima ove moderne serije.

3.1. General

Our single-phase TEFC (IC 411) induction motors are suitable for various applications such as ventilation systems, supply of compressed air, pumping fluids, agriculture and food processing, small work shops, households etc.

They are distinguished by high quality of used materials, greased for life bearings, durable insulating system and low running costs.

Single-phase capacitor run series 5AZC motors are particularly suitable for a wide range of drives, especially for those with easy start, because of huge number of drives started with no load or under a very small load. They are especially suitable for driving of fans, circular saws, grinding machines, centrifugal pumps, various mills, drilling machines etc.

Single phase capacitor run and capacitor start motors series 5AZCD (motors with increased starting torque) are suitable to be used for drives in very hard working conditions. In particularly, they are intended to be used for compressor drives, various squeezers, mills, thresher drives and other heavy agricultural machines. During starting period, start capacitor is switched parallelly with run capacitor, and it is switched off by centrifugal switch when motor reaches around 80% of rated revolving speed.

Terminal box of single-phase motors, in basic design, is made of plastic and it contains (beside terminal plate) capacitors. Terminal box is equipped with cable gland for cable connection to power supply.

Capacitors. Motors of 5AZC series are equipped with run capacitor with rated voltage and capacities as given in TECHNICAL DATA table. Motors of 5AZCD series (motors with increased starting torque) besides run capacitor are equipped with electrolytic starting capacitor with rated values as given in table TECHNICAL DATA.

Rated values of all capacitors given in tables refer to power source of 230V. All of that gives you additional confidence that your fans, pumps, compressors or other drive system will be appropriately equipped with this modern motor series.

3.1. Allgemeine Angaben

Unsere einphasigen Asynchronmotoren mit Käfigläufer voellig geschlossener Ausfuehrung mit Eigenluefter gekuehlt (Kuehlungsart IC411) sind fuer verschiedene Anwendungen geeignet wie Belueftung, Pressluftversorgung, Fluessigkeitenbefoerderung, Landwirtschaft und Lebensmittelindustrie, kleine Produktionsstaette, Haushalte usw. Sie zeichnen sich durch hochwertige, eingesetzte Werkstoffe, dauergeschmierte Lagerung, witterungs- und korrosionsbestaendigen Endanstrich, ausdauerliche Isolierung und niedrige Einsatzkosten aus.

Einphasige Asynchronmotoren mit dem Betriebskondensator der Baureihe 5AZC sind fuer einen Großteil der Antriebe geeignet, insbesondere für jene mit leichtem Anlauf, wenn man in Betracht zieht, dass ein Großteil der Antriebe ganz unbelastet oder unter kleinem Last angelaufen wird. Besonders geeignet sind sie fuer die Antriebe von Ventilatoren, Kreissaegen, Schleifmaschinen, Zentrifugalpumpen, verschiedene Muehlen, Bohrmaschinen u.ae.

Einphasige Asynchronmotoren mit dem Anlauf- und Betriebskondensator 5AZCD (Motoren mit erhoehetem Anlaufmoment) finden die Verwendung in Antrieben unter schweren Arbeitsbedingungen. Besonders geeignet sind sie fuer die Kompressorantriebe, verschiedene Pressen, Muehlen, Dreschermaschinen und andere schweren landwirtschaftlichen Maschinen. Der Anlaufkondensator ist waehrend des Anlaufs parallel mit dem Betriebskondensator eingeschaltet und wird durch den Fliehkraftschalter, wenn der Motor ungefaehr 80% der Nenndrehzahl erreicht, ausgeschaltet.

Der Klemmenkasten einphasiger Motoren in der Grundausfuehrung ist aus dem Kunststoff gefertigt und neben dem Klemmenbrett befinden sich im Klemmenkasten auch die Kondensatoren. Der Klemmenkasten ist mit der Kabelverschraubung fuer die Anschlusskabeleinfuehrung ausgeruestet.

Die Motoren der Baureihe 5AZC sind mit den Betriebskondensatoren der Nennspannungen und Kapazitaeten, die in der Tabellen technischer Daten angefuehrt sind, ausgestattet. Die Motoren der Baureihe 5AZCD (Motoren mit erhoehetem Anlaufmoment) haben neben dem Betriebskondensator auch einen elektrolitschen Anlaufkondensator, mit Nenngroessen wie sie in den Tabellen technischer Daten angegeben sind. Die Nennwerte aller in den Tabellen angefuehrter Kondensatoren gelten fuers Netz der Nennspannung von 230V. All das gibt Ihnen zusaetzhliche Sicherheit, dass Ihre Antriebssysteme ausgeruestet mit diesen modernen Motorenbaureihen noch konkurrenzfaehiger und verlaesslicher sein werden.

Tablica 3.1. / Table 3.1. / Tabelle 3.1.

SMJER VRTNJE / DIRECTION OF ROTATION / DREHRICHTUNG		
	DESNI SMJER CLOCKWISE RECHTSRICHTUNG	LIJEVI SMJER COUNTER CLOCKWISE LINKSRICHTUNG
IZVEDBA S TRAJNO SPOJENIM KONDENZATOROM DESIGN WITH RUN CAPACITOR AUSFUEHRUNG MIT DEM BETRIEBSKONDENSATOR		
HEMA PRIKLJUČKA NA MREŽU POWER SUPPLY CONNECTION DIAGRAM KLEMMENSCHALTPLAN AUFS NETZ		
IZVEDBA S TRAJNO SPOJENIM I ZALETNIM KONDENZATOROM DESIGN WITH CAPACITOR START AND CAPACITOR RUN AUSFUEHRUNG MIT DEM BETRIEBS-UND ANLAUFKONDENSATOR		
HEMA PRIKLJUČKA NA MREŽU POWER SUPPLY CONNECTION DIAGRAM KLEMMENSCHALTPLAN AUFS NETZ		

CFS - **centrifugalna sklopka***centrifugal switch*

Fliehkraftschalter

Aph - **pomoćna faza***auxiliary phase*

Hilfsphase

Mph - **glavna faza***main phase*

Hauptphase

3.3. Standardne izvedbe

3.3. Standard design

3.3. Grundaufuehrung

Tablica 3.2. / Table 3.2. / Tabelle 3.2.

Standardna izvedba	Standard design	Grundaufuehrung
Norme: IEC 60034, 60072, 60038 i 60085	Standards: IEC 60034, 60072, 60038 i 60085	Normen: IEC 60034, 60072, 60038 i 60085
Serije i veličine: 5AZC 63-100 (samo s radnim kondenzatorom) 5AZCD 71-100 (visoki potezni moment, zaletni i radni kondenzator, ugrađena centrifugalna sklopka) Obje serije u siluminskom tlačno lijevanom orebrenom kućištu s odlivenim nogama	Series and frame sizes: 5AZC 63 – 100 (capacitor run only) 5AZCD 71 – 100 (high starting torque, capacitor start and run, centrifugal switch built in) Both series in die casted aluminium alloy ribbed housing with die casted feet	Baureihen und Bauformen: 5AZC 63 – 100 (nur mit dem Betriebskondensator) 5AZCD 71–100 (hoher Anlaufmoment, mit dem Betriebs- und Anlaufkondensator, Fliehkraftschalter eingebaut) Beide Baureihen im gerippten Aluminiumdruckgussgehäuse mit gegossenen Füßen.
Oblici ugradnje: IM B3, B5, B35, B14 i B34	Mounting designs: IM B3, B5, B35, B14 i B34	Bauformen: IM B3, B5, B35, B14 i B34
Priključni ormarić: od termoplasta, gledano sa strane pogonskog vratila u oblicima IM B3, B35 i B34 smješten gore	Terminal box: from thermal plastic, situated on top viewing from DE for mounting designs IM B3, B5 and B14	Klemmenkasten: aus Kunststoff, in Bauformen IM B3, B35 und B34 oben positioniert, von Wellenantriebsseite betrachtet
Raspon snaga: 0.12 – 2.5 kW	Power range: 0.12 – 2.5 kW	Leistungsbereich 0.12 – 2.5 kW
Vrsta pogona: S1 (za okolinu –20°C do +40°C i postav do 1000 m nm.)	Duty: S1 (for ambient –20°C to +40°C and up to 1000 ASL)	Betriebsart: S1 (für Umgebungstemperatur von –20°C bis +40°C und Aufstellung bis 1000 m ueber den Meeresspiegel)
Napon i frekvencija: 230V ± 5% i 50Hz	Voltage and frequency: 230V ± 5% i 50Hz	Spannung und Frequenz: 230V ± 5% i 50Hz
Broj polova: 2, 4 i 6 u 5AZC seriji 2 i 4 u 5AZCD seriji	Number of poles: 2, 4 and 6 in 5AZC series 2 and 4 in 5AZCD series	Polzahl: 2, 4 und 6 in der 5AZC Baureihe 2 und 4 in der 5AZCD Baureihe
Stupanj zaštite: IP 54	Protection index: IP 54	Schutzart: IP 54
Klasa izolacije: F (zagrijavanje u B)	Insulation class: F (rise in B)	Isolationsklasse: F (Erwaermung im B)
Ton boje: neobojan	Colour tone: non-painted	Farbton: unlackiert

Tablica 3.3. / Table 3.3. / Tabelle 3.3.

Dodatne izvedbe motora	Optional motor design	Optionale Motorausfuehrung
drugi naponi (ili višenaponski) i frekvencije	<i>other voltages (or multi-voltages) and frequencies</i>	andere Spannungen(oder Mehrspannungsbereich)und Frequenzen
drugi broj pari polova	<i>other number of poles</i>	andere Polzahlen eintouriger Motoren
drugi oblici ugradnje	<i>other mounting arrangements</i>	andere Bauformen
termička zaštita (PTC sonde ili termoprotektori)	<i>thermal protection (PTC thermistors or thermal swithches)</i>	thermischer Schutz (PTC Kaltleiter oder Thermoschalter)
dva izlazna kraja vratila	<i>two shaft free ends (on DE and on NDE)</i>	zwei Wellenenden
izolacija za temperaturnu klasu "H"	<i>„H“ insulation class</i>	Isolierung fuer die Waermeklasse„H“
posebne prirubnice i krajevi vratila	<i>special flanges and shaft ends</i>	Sonderflanschen und Sonderwellenenden
izvedba s ormarićem desno ili lijevo	<i>terminal box on right or left side</i>	Klemmenkastenausfuehrung rechts oder links
ventilatorska kapa sa zaštitom od padalina ili lebdećih tekstilnih vlakana	<i>fan cover with protection from rainfall and textile fibres</i>	Luefterhaube mit dem Regenschutzdach oder Textilhaube
ostali tonovi boje i/ili vrste premaza	<i>other colour tones and/or surface paints</i>	andere Farbtoene und/oder Anstrichsarten
bez ventilacije (način hlađenja IC410)	<i>non-ventilated (cooling type IC410)</i>	unbelüftet (Kühlungsart IC410)
namot za tropske uvjete	<i>winding for tropical environment</i>	Tropenwicklung
grijači namota	<i>winding heaters</i>	Stillstandheizungen
stupanj zaštite IP55	<i>protection index up to IP55</i>	Schutzgrad bis zu IP55
i ostale izvedbe prema želji kupca	<i>and other customer demand based design</i>	und andere kundenspezifische Ausfuehrungen
prigrađeno na motor	<i>built-in</i>	auf den Motor angebaut
priključni kabel, grebenasta sklopka	<i>connecting cable, drum type switch</i>	Anschlusskabel,Nockenschalter
podnaponski relej u kombinaciji s termičkom zaštitom (termoprotektori)	<i>under-voltage relay in combination with thermal protection (thermo-protectors)</i>	Unterspannungsrelais kombiniert mit thermischem Schutz (Thermoschalter)
motorska zaštitna sklopka	<i>motor protective switch</i>	Motorschutzschalter
sigurnosna el.magnetska kočnica	<i>fail-safe spring loaded DC brake</i>	elektromagnetische Sicherheitsbremse(nur fuer AZC Baureihe!)
i ostale izvedbe prema želji kupca	<i>and other customer demand based design</i>	und andere kundenspezifische Ausfuehrungen

3.4. Tehnički podaci

Jednofazni asinkroni kavezni motori s trajno uključenim kondenzatorom serije 5AZC

3.4. Technical data

Single-phase induction motors with run capacitor (permanently connected) series 5AZC

3.4. Technische Daten

Einphasige Asynchronmotoren mit Käfigläufer mit einem Dauerbetriebskondensator der Baureihe 5AZC

Tablica 3.4. / Table 3.4. / Tabelle 3.4.

2p=2			50Hz				3000 min ⁻¹			
P (Kw)	Motor type	n (min-1)	η (%)	cos φ	I _n (A)	$\frac{I_k}{I_n}$	$\frac{M_k}{M_n}$	C (μF)	U (V)	m (kg)
0.18	5AZC 63A-2	2850	58	0.97	1.65	3.5	0.80	10	450	4.1
0.25	5AZC 63B-2	2850	58	0.96	2	3.5	0.90	12.5	450	4.6
0.37	5AZC 71A-2	2700	58	0.88	3.3	2.3	0.55	10	450	5.9
0.55	5AZC 71B-2	2700	62	0.90	4.2	2.7	0.45	12.5	450	6.7
0.75	5AZC 80A-2	2750	62	0.90	6.0	2.8	0.55	20	450	9.4
1.1	5AZC 80B-2	2740	70	0.92	7.7	3.0	0.50	25	450	9.6
1.5	5AZC 90SB-2	2730	70	0.94	11	3.0	0.50	50	450	12
2.2	5AZC 90LB-2	2740	73	0.98	13.2	3.0	0.45	100	450	17
2.5	5AZC 100LB-2	2850	74	0.90	16.5	4.2	0.40	80	450	23

Tablica 3.5. / Table 3.5. / Tabelle 3.5.

2p=4			50Hz				1500 min ⁻¹			
0.12	5AZC 63A-4	1380	53	0.99	1.3	2.5	0.90	8	450	4.1
0.18	5AZC 63B-4	1380	57	0.98	1.6	2.5	0.65	8	450	4.6
0.25	5AZC 71A-4	1400	60	0.91	2.0	2.5	0.65	8	450	5.7
0.37	5AZC 71B-4	1370	60	0.97	2.8	2.4	0.75	14	450	6.7
0.55	5AZC 80A-4	1390	65	0.92	4.1	2.9	0.65	20	450	10.5
0.75	5AZC 80B-4	1370	70	0.90	5.1	2.6	0.60	25	450	11.3
1.1	5AZC 90SB-4	1430	67	0.95	7.5	3.7	0.60	50	450	13.1
1.5	5AZC 90LB-4	1430	71	0.93	10	4.0	0.50	50	450	17.9
2.2	5AZC 100LD-4	1420	77	0.95	13.5	4.0	0.40	50	450	27

Tablica 3.6. / Table 3.6. / Tabelle 3.6.

2p=6			50Hz				1000 min ⁻¹			
0.12	5AZC 71A-6	940	42	0.90	1.5	1.8	0.65	8	450	4.9
0.18	5AZC 71B-6	930	46	0.85	2.5	2.1	0.53	10	450	7
0.25	5AZC 80A-6	910	55	0.90	2.4	2.5	0.70	12.5	450	8.6
0.37	5AZC 80B-6	900	58	0.88	3.3	2.5	0.70	16	450	10.4
0.55	5AZC 90LB-6	910	59	0.85	5.1	2.5	0.60	25	450	12.7

VAŽNO: u svrhu zaštite kondenzatora, ne preporučuje se startati motore više od dvadeset puta u jednom satu.

Jednofazni asinkroni kavezni motori s pogonskim i zaletnim kondenzatorom serije 5AZCD

IMPORTANT: For the purpose of capacitor protection, it is not recommended to start motors more than 20 times within one hour.

Single-phase induction motors series 5AZCD with capacitor start and run

WICHTIG: Wegen des Kondensatorschutzes ist es nicht empfehlenswert, die Motoren mehr als zwanzig mal pro Stunde zu starten.

Einphasige Asynchronmotoren mit Käfigläufer mit dem Betriebs- und Anlaufkondensator der Baureihe 5AZCD

Tablica 3.7. / Table 3.7. / Tabelle 3.7.

2p=2			50Hz				3000 min ⁻¹			
P (Kw)	Motor type	n (min-1)	η (%)	cos φ	I _n (A)	$\frac{I_k}{I_n}$	$\frac{M_k}{M_n}$	C (μF)	U (V)	m (kg)
0.37	5AZCD 71A-2	2800	60	0.84	3.5	3.8	1.75	8 40-50	450 280	6.7
0.55	5AZCD 71B-2	2820	62	0.86	5.6	4.5	1.75	10 40-50	450 280	7.6
0.75	5AZCD 80A-2	2860	67	0.86	10.5	4.6	2.0	20 63-80	450 280	11.2
1.1	5AZCD 80B-2	2860	69	0.84	15	4.5	2.0	25 80-100	450 280	11.5
2.2	5AZCD 90SB-2	2850	72	0.88	10.5	4.6	1.85	16 80-100	450 280	14.6
2.2	5AZCD 90LB-2	2850	71	0.88	15	4.5	1.9	25 80-100	450 280	15.4
2.2	5AZCD 100LB-2	2830	71	0.90	15	4.5	2.2	20 80-100	450 280	26

Tablica 3.8. / Table 3.8. / Tabelle 3.8.

2p=4			50Hz				1500 min ⁻¹			
0.25	5AZCD 71A-4	1415	60	0.91	2.0	4.1	1.7	10 50-63	450 280	7.6
0.37	5AZCD 71B-4	1380	64	0.98	2.6	4.4	1.6	14 63-80	450 280	8.6
0.55	5AZCD 80A-4	1410	69	0.92	4.0	4.0	1.5	16 63-80	450 280	11
0.75	5AZCD 80B-4	1400	67	0.91	5.5	3.7	1.75	16 50-63	450 280	12.5
1.1	5AZCD 90SB-4	1380	67	0.92	7.7	3.9	1.7	16 80-100	450 280	13.7
1.5	5AZCD 90LB-4	1430	73	0.93	10	3.7	2.3	25 80-100	450 280	13.5
2.2	5AZCD 100LD-4	1390	70	0.96	12.7	3.5	1.9	40 80-100	450 280	28

Ostali polariteti izrađuju se na poseban upit.

U svrhu zaštite kondenzatora, ne preporučuje se pokretati motore više od 20 puta u jednom satu. I_k/I_n - odnos struja kod pokretanja (odnos struje kratkog spoja i nazivne struje kod nazivnog momenta)

M_k/M_n - odnos momenta kod pokretanja (odnos momenta u kratkom spoju i nazivnog momenta motora)

Ct - trajni kondenzator

Cz - zaletni kondenzator

Other polarities are available on request.

For the purpose of capacitor it is not recommended to start motors more than 20 times within one hour.

I_k/I_n - ratio of currents during starting (ratio between locked rotor current and rated current at rated torque)

M_k/M_n - ratio of torques during starting (ratio between locked rotor torque and rated torque)

Ct - run capacitor

Cz - start capacitor

Andere Polzahlen werden auf Sonderanfrage gefertigt.

WICHTIG: Wegen des Kondensatorschutzes ist es nicht empfehlenswert die Motoren mehr als zwanzig mal pro Stunde zu starten.

I_k/I_n - Startverhaeltnis der Stroeme (Verhaeltnis des Anlaufs- u.Nennstroms beim Nennmoment)

M_k/M_n - Startverhaeltnis der Momente (Verhaeltnis des Anlaufs-u.Nennmoments)

Ct - Betriebskondensator

Cz - Anlasskondensator



IEC veličina

63 – 100 (5.xAZC serija)

71 – 100 (5.xAZCD serija)

Popis rezervnih dijelova s uputom za naručivanje nalazi se u poglavlju 7. Rezervni dijelovi.

Svi navedeni tehnički podaci su informativni te za njih proizvođač Končar-MES pridržava pravo promjene bez prethodne najave.

IEC frame size

63 – 100 (5.xAZC series)

71 - 100 (5.xAZCD series)

Spare part list with ordering instructions is given in chapter 7. *Spare parts.*

All technical data are informative and manufacturer Končar-MES reserves right to their change without prior notice.

IEC Baugröße

63 – 100 (5.xAZC Baureihe)

71 – 100 (5.xAZCD Baureihe)

Die Liste der Ersatzteile und Bestellanweisung befinden sich im Kapitel 7. – Ersatzteile.

Alle technischen Daten sind informativ und der Hersteller Končar-MES behält das Änderungsrecht ohne Vorankündigung.

3.5. Mjerne skice

Serijska 5AZC i 5AZCD
Motori s nogama

3.5. Dimensional drawing

Series 5AZC and 5AZCD
Motors with feet

3.5. Masszeichnungen

Baureihen 5AZC und 5AZCD
Fußmotoren

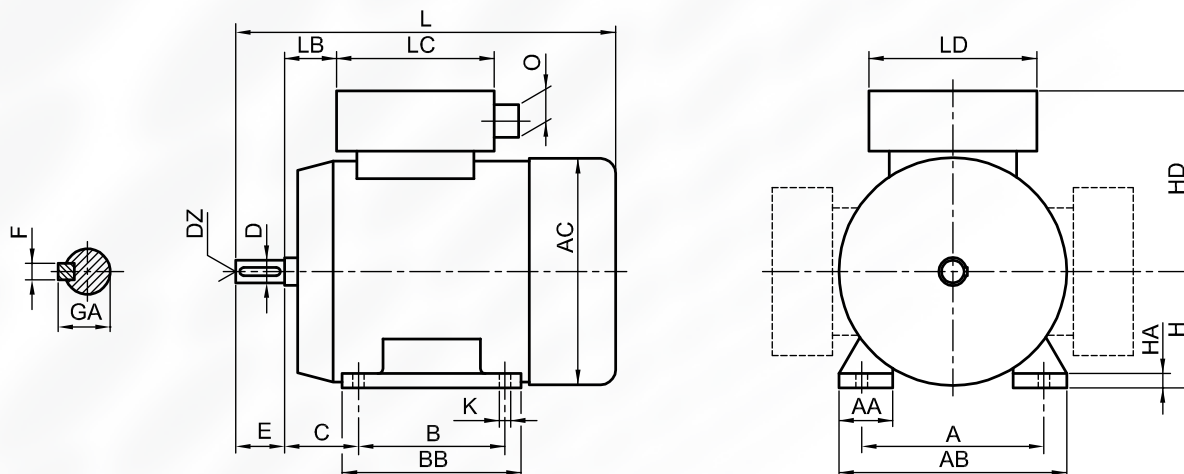

Tablica 3.9. / Table 3.9. / Tabelle 3.9.

Tipaska oznaka	IM B3, IM B5, IM B14											IM B3									
	AC	D	DZ	E	F	GA	HD	L	LB	LC	LD	O	A	AA	AB	B	BB	C	H	HA	K
5AZC 63	123	11j6	M4	23	4	12,5	118	214	16	117	87	Table 1.20.	100	22	120	80	105	40	63	10	7x12
5AZC 71	139	14j6	M5	30	5	16	126	235	23	117	87		112	26	137	90	109	45	71	11	7x11
5AZC 80	156	19j6	M6	40	6	21,5	149	270	23	140	110		125	36	160	100	125	50	80	11	8x16
5AZC 90S	176	24j6	M8	50	8	27	155	300	29	140	110		140	41	170	100	130	56	90	13	9x16
5AZC 90L	176	24j6	M8	50	8	27	155	325	29	140	110		140	41	175	125	155	56	90	13	9x16
5AZC 100	194	28j6	M10	60	8	31	163	365	35	140	110		160	47	200	140	170	63	100	12	11x22
5AZCD 71	139	14j6	M5	30	5	16	142	285	47	131	116		112	26	137	90	109	45	71	11	7x11
5AZCD 80	156	19j6	M6	40	6	21,5	158	317	55	175	125		125	36	160	100	125	50	80	11	8x16
5AZCD 90S	176	24j6	M8	50	8	27	164	360	59	175	125		140	41	170	100	130	56	90	13	9x16
5AZCD 90L	176	24j6	M8	50	8	27	164	385	59	175	125		140	41	175	125	155	56	90	13	9x16
5AZCD 100	194	28j6	M10	60	8	31	174	435	108	175	125		160	47	200	140	170	63	100	12	11x22

Motori s prirubicom

Flange mounted motors

Flanschmotoren

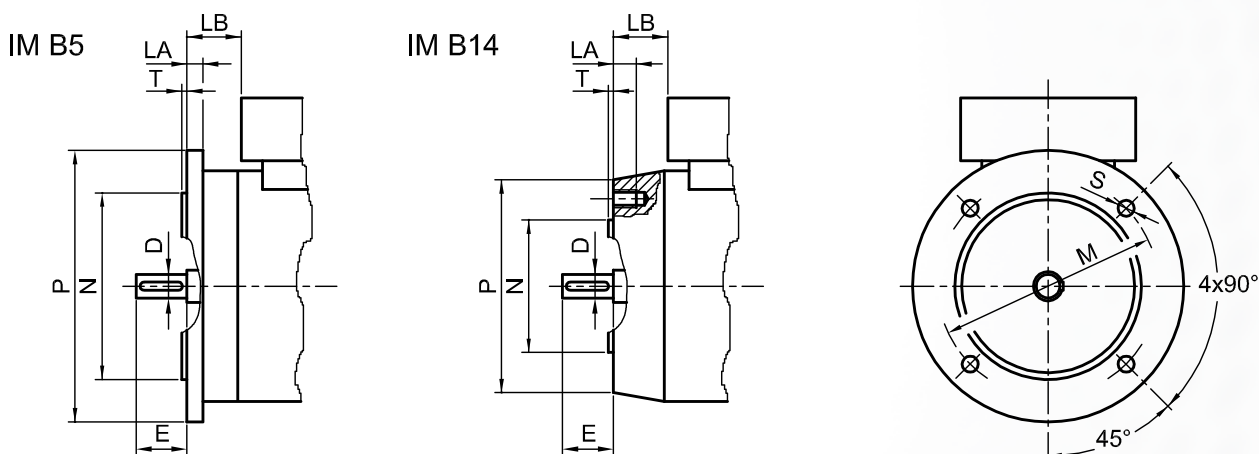

Tablica 3.10. / Table 3.10. / Tabelle 3.10.

Tipaska oznaka	IM B5						IM B14 - manja					IM B14 - veća						
	LA	M	N	P	S	T	LA	M	N	P	T	LA	M	N	P	S	T	
5AZC 63	9	115	95j6	140	9,5	3	8	75	60j6	90	3							
5AZC 71	10	130	110j6	160	9,5	3,5	8	85	70j6	105	2,5	10	115	95j6	140	M8	3	
5AZC 80	10	165	130j6	200	11,5	3,5	8	100	80j6	120	3	10	130	110j6	160	M8	3,5	
5AZC 90S	10	165	130j6	200	12	3,5	10	115	95j6	140	3	10	130	110j6	160	M8	3,5	
5AZC 90L	10	165	130j6	200	12	3,5	10	115	95j6	140	3	10	130	110j6	160	M8	3,5	
5AZC 100	15	215	180j6	250	15	4	10	130	110j6	160	3	12	165	130j6	200	M10	3,5	
5AZCD 71	10	130	110j6	160	9,5	3,5	8	85	70j6	105	2,5	10	115	95j6	140	M8	3	
5AZCD 80	10	165	130j6	200	11,5	3,5	8	100	80j6	120	3	10	130	110j6	160	M8	3,5	
5AZCD 90S	10	165	130j6	200	12	3,5	10	115	95j6	140	3	10	130	110j6	160	M8	3,5	
5AZCD 90L	10	165	130j6	200	12	3,5	10	115	95j6	140	3	10	130	110j6	160	M8	3,5	
5AZCD 100	15	215	180j6	250	15	4	10	130	110j6	160	3	12	165	130j6	200	M10	3,5	

IEC veličina

63 – 100 (5.xAZC serija)

71 – 100 (5.xAZCD serija)

Popis rezervnih dijelova s uputom za naručivanje nalazi se u poglavlju 7. Rezervni dijelovi.

Svi navedeni tehnički podaci su informativni te za njih proizvođač KONČAR-MES pridržava pravo promjene bez prethodne najave.

IEC frame size

63 – 100 (5.xAZC series)

71 - 100 (5.xAZCD series)

Spare part list with ordering instructions is given in chapter 7. Spare parts.

All technical data are informative and manufacturer KONČAR-MES reserves right to their change without prior notice.

IEC Baugröße

63 – 100 (5.xAZC Baureihe)

71 – 100 (5.xAZCD Baureihe)

Die Liste der Ersatzteile und Bestellungsanweisung befinden sich im Kapitel 7.– Ersatzteile.

Alle technischen Daten sind informativ und der Hersteller KONČAR-MES behält sich das Änderungsrecht ohne Vorankündigung.



KONČAR
KONČAR - MES d.d.

Fallerovo šetalište 22
10000 Zagreb
Hrvatska / Croatia

PRODAJA / SALES / VERKAUF

Hrvatska / Croatia / Kroatien

Tel. +385 (0)1 3667 273

+385 (0)1 3666 563

Fax. +385 (0)1 3667 287

E-mail: prodaja@koncar-mes.hr

Izvoz / Export / Export

Tel. +385 (0)1 3655 711

Fax. +385 (0)1 3667 282

E-mail: sales@koncar-mes.hr

export@koncar-mes.hr

